

TBRACING



ALIBABA WEBSITE
2023 CATALOGUE



TAIWAN BIKE RACK CO.,LTD.
No.83, Lane 61, Sianguang Rd.,
Sihu Township, Changhua
County 51451,Taiwan (R.O.C)

Tel +886-4-881-3634
Fax +886-4-881-3924
sales@tbracing.com.tw
www.tbracing.com.tw



OFFICIAL AUTHORIZED PROFESSIONAL MANUFACTURER

TBRACING



**PERFORMANCE
RACING PRODUCTS**

08 HARNESSES

- / FIA 8853-2016 harness standard
- / SFI 16.1 specification
- / SFI 16.5 specification
- / UTV harnesses
- / Tuning harnesses
- / Seat belt

48 SEAT BELT COMPONENT

- / Hardware
- / Latch and link system
- / Ratchet mechanism

55 ACCESSORIES

- / Window nets & Helmet net
- / Tow straps
- / Arm Restraint
- / Cam buckle & Ratchet buckle & Overcenter buckle
- / Tie down straps & Spare tire strap
- / Padding
- / Hand tools

68 VEHICLE EQUIPMENT

- / Steering wheel
- / Steering wheel quick release
- / Hood pins lock clip
- / Coupe-circuit
- / Hydranlic handbrake
- / Fire extinguisher
- / Racing seat

84 DRIVER EQUIPMENT

- / Helmets

TAIWAN-BASED, PROFESSIONAL MANUFACTURER

TAIWAN BIKE RACK CO.,LTD (Brand: TBRACING), established in 1995 in Taiwan, wholly-owned operating companies. We are over 25 years of professional manufacturing experience in Taiwan.

Our factory has

- 6 stamping line, from 15 tons to 300 tons stamping machine.
- 10 ribbon machine
- 12 sewing machine
- 5 driller
- 3 Assembly line
- 2 die casting machine
- 1 laser engraving

We are devoted in ODM/OEM service, and provide new technologies, new solutions to customers.



OUR PRODUCTS

TBRACING manufacture precision products, like seat belt hardware and components, FIA & SFI international certification racing seat belts, seat belt buckle, restraint buckle, cam buckle, tie down straps, windows net, and other related safety equipment.



QC SYSTEM

In order to build up a good quality control systems, TBRACING follow

- ISO 9001:2015
- FIA standard 8853-2016 Homologation standards
- FIA standard 8854/98 Homologation Standards
- SFI 16.1 specification
- SFI 16.5specification
- SFI 16.6 specification
- SFI 27.1 specification

Also set up tons of professional test equipment which can make sure TBRACING's product are good.

SAFE TESTING

Our quality inspectors are responsible for inspecting all areas of production from raw material to packing condition. Our team take good care to ensure all components and labeling meet customer require. The quality of TBRACING products is the result of intensive R&D which allows to achieve the highest levels of performance and safety.



ISO9001:2015

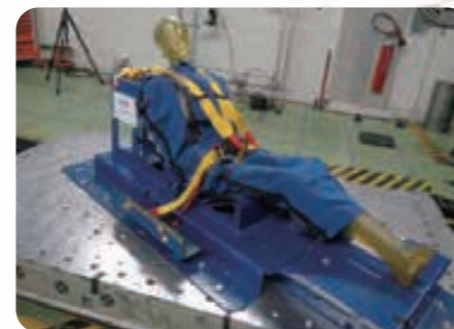

PRIORITY

Become one of the good service company is always TBRACING's Priority.

TBRACING is customer-oriented service, only provide stable/good quality products and service to clients.

In order to reach the customers requirement, we have variety production department line to offer. From the raw material to finished products, we can take good care on each steps.

TBRACING is able to produce and supply safety belts for several different applications.

WHY CHOOSE US

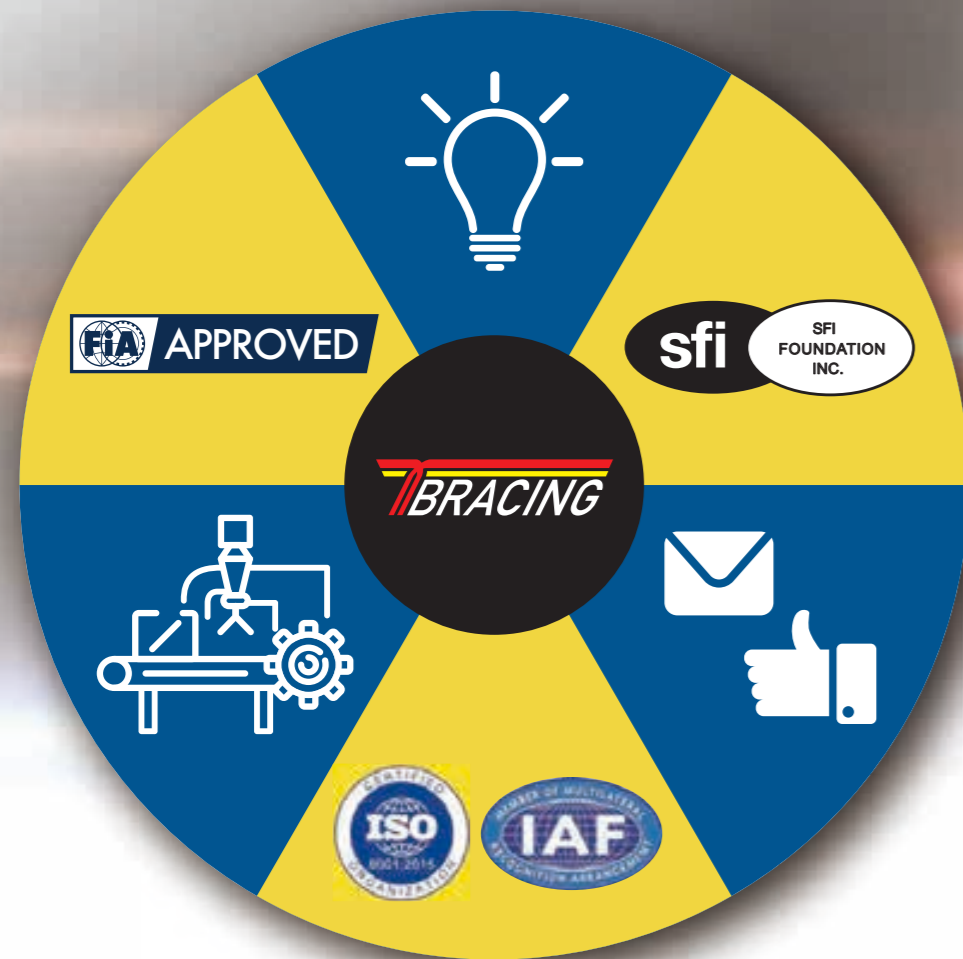

- Manufacturer with global FIA international certification.
- Possess the American SFI safety quality certification.
- Possess patents for new inventions and designs in many countries.
- Possess professional OEM and ODM capability technology.
- Comply with ISO 9001 quality management requirements.
- High-quality sales interaction, perfect after-sales service.

APPLICATIONS



RALLY CAR

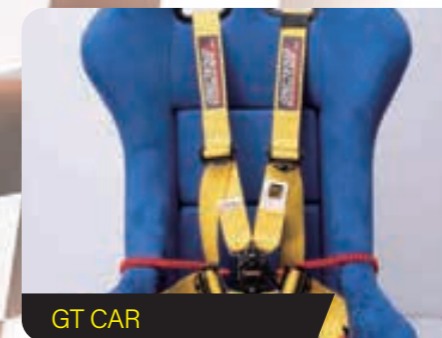

GT CAR



GO CART



BUS

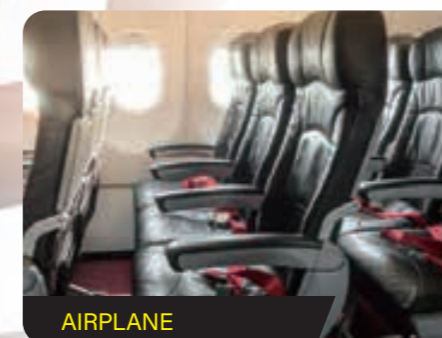

AIRPLANE



AMBULANCE



OFF ROAD VEHICLE



ATV



UTV

ULTRA BUCKLE-INTRODUCTION



PATENT

3



- 1 The strongest safety buckle lead in the world !!!!!
- 2 The buckle and crotch tongue are combined into an integrated design to relieve the pressure of drivers wearing safety belts. Moreover, data proves that the strength of the integrated seat belt buckle is better.
- 3 EU design patent , Taiwan design patent.
- 4 The new lever can be released more effortlessly and quickly.



■ PAT. No 015010522-0001

■ PAT. D226166



- We use the sewn structure to allow more space in the crotch straps area, which can improve comfort and reduce pressure when racers wear safety belts.
- One-piece design, better structural strength, and the webbing can fit the thighs, ergonomic technology.



- We attach an anti-slip pad to the back of the top shoulder strap to increase the anti-slip and make the harness device more stable for racers to wear.

ULTRA



MANUFACTURER: TBRACING
MODEL: SPORT PLUS
HOM. NO: SH.059.19-T-6
FIA STANDARD: 8853-2016

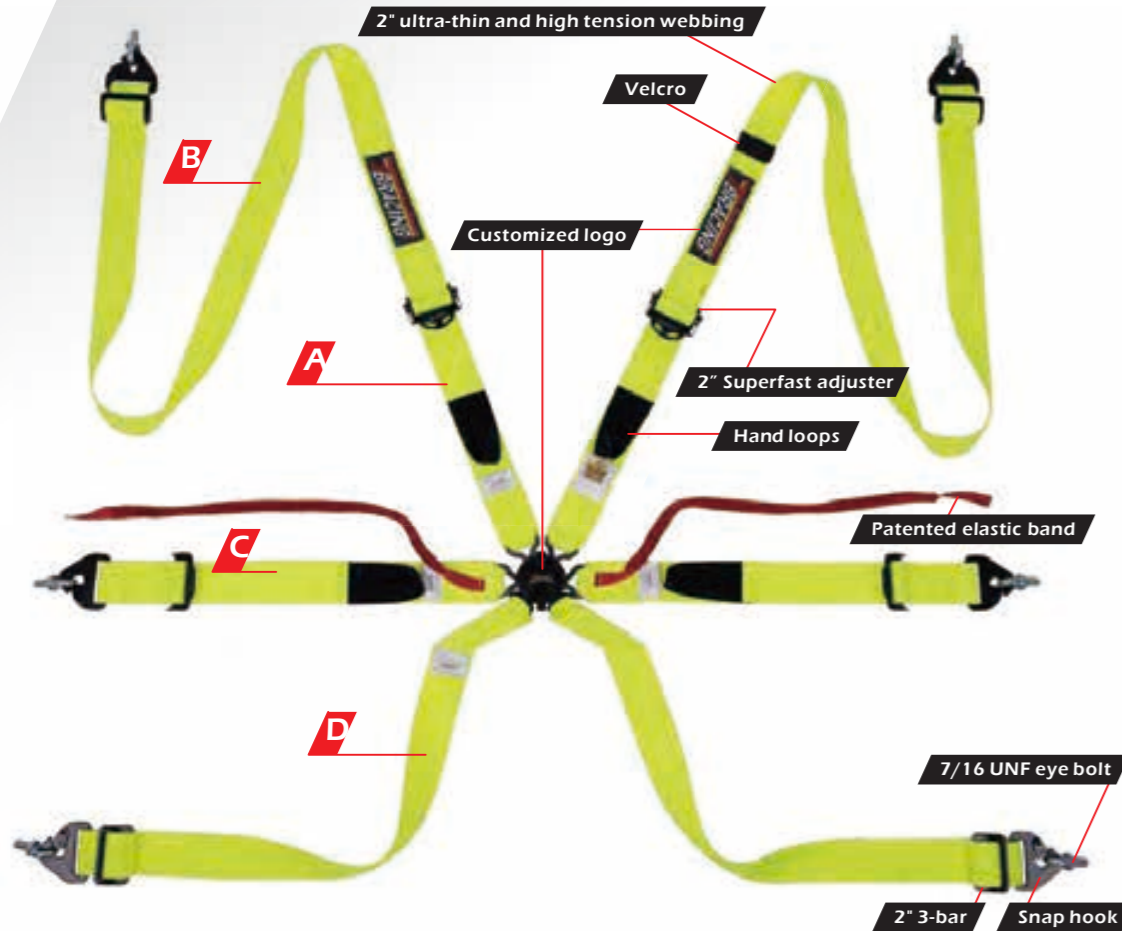

ITEM : ULTRA

- FIA approved 8853-2016
- The one-piece sewing structure improves the wearing comfort of racers and reduces pressure.
- New fluorescent color with Ultra-thin and high tension webbing
- NEW patent 2" ultra-light steel adjuster on the shoulder.
- Add the patented elastic band, which help the belts quick release, and easy let driver get in the seat.
- Using the lightweight steel adjusters for a smoother faster and secure adjustment on the lap belts.
- Securing Velcro on shoulder belts.
- Delivered with 7/16 UNF eye bolts.
- Grab loops in the sewing structure on the shoulder and lap side.

STANDARD MEASURES

A 500mm **B** 1400mm **C** 700mm
D 600mm **GROSS WEIGHT** 2.16KG

STANDARD COLORS

- | | | | | | | | | | | | |
|-------|-------------------------|-------|------------------------|-------|-----------------|-------|----------------|-------|-------------|-------|--------------------------|
| 10001 | ULTRA BLACK | 10002 | ULTRA RED | 10003 | ULTRA BLUE | 10004 | ULTRA YELLOW | 10005 | ULTRA GREEN | 10006 | ULTRA PURPLE |
| 10007 | ULTRA PINK | 10008 | ULTRA ORANGE | 10009 | ULTRA AQUA BLUE | 10010 | ULTRA GREY | 10011 | ULTRA CAMO | 10012 | ULTRA FLUORESCENT YELLOW |
| 10013 | ULTRA FLUORESCENT GREEN | 10014 | ULTRA FLUORESCENT PINK | 10015 | ULTRA TREE | 10016 | ULTRA CHAMPION | | | | |

ULTRA-D



MANUFACTURER: TBRACING
MODEL: SPORT PLUS
HOM. NO: SH.059.19-T-6
FIA STANDARD: 8853-2016

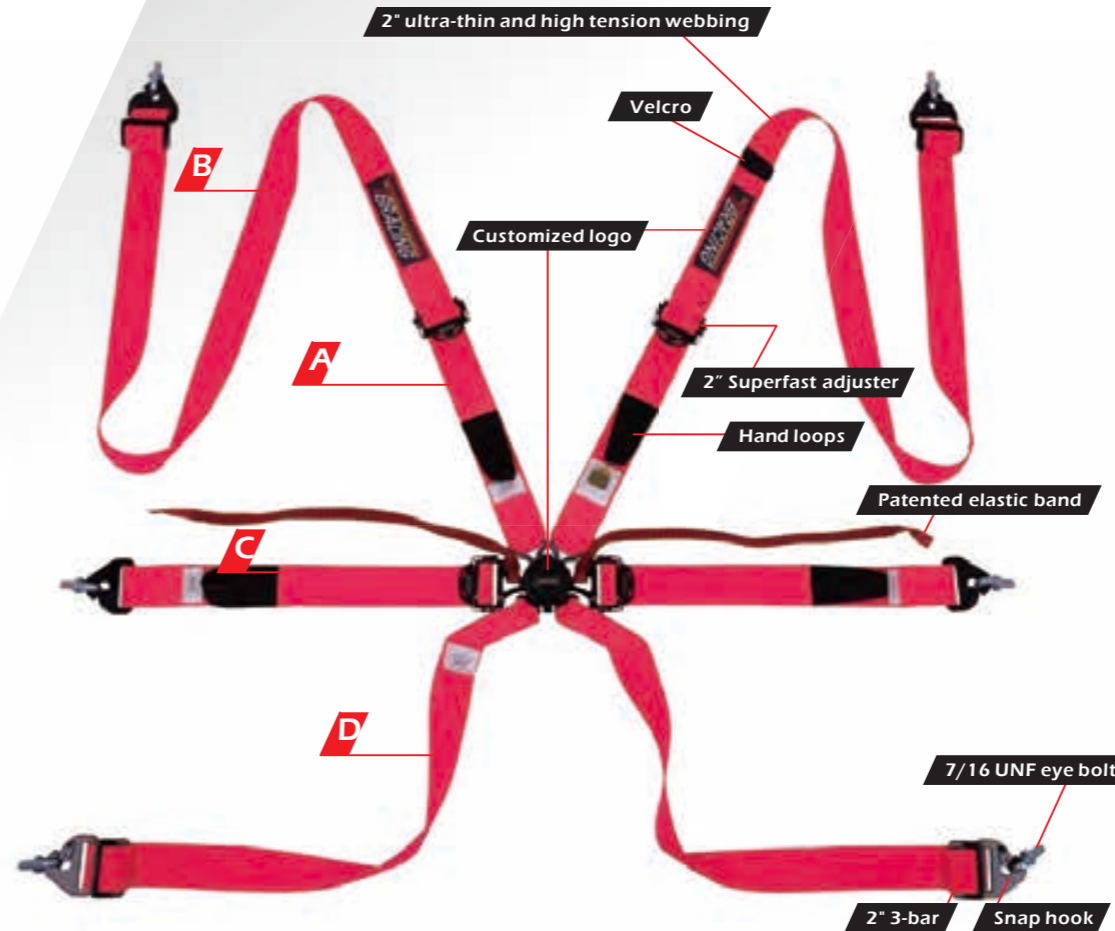

ITEM : ULTRA-D

- FIA approved 8853-2016
- The one-piece sewing structure improves the wearing comfort of racers and reduces pressure.
- New fluorescent color with Ultra-thin and high tension webbing
- Superlight printing logo
- Add the patented elastic band, which help the belts quick release, and easy let driver get in the seat.
- Pull down systems.
- NEW patent 2" ultra-light steel adjuster and 2" ultra-light steel tongue adjuster on the shoulder and on the lap strap.
- Using the lightweight steel adjusters for a smoother faster and secure adjustment on the lap belts.
- Securing Velcro on shoulder belts.
- Delivered with 7/16 UNF eye bolts.
- Grab loops in the sewing structure on the shoulder and lap side.

STANDARD MEASURES

A 500mm **B** 1400mm **C** 700mm
D 600mm **GROSS WEIGHT** 2.16KG

STANDARD COLORS

- | | | | | | | | | | | | |
|-------|---------------------------|-------|--------------------------|-------|-------------------|-------|------------------|-------|---------------|-------|----------------------------|
| 11001 | ULTRA-D BLACK | 11002 | ULTRA-D RED | 11003 | ULTRA-D BLUE | 11004 | ULTRA-D YELLOW | 11005 | ULTRA-D GREEN | 11006 | ULTRA-D PURPLE |
| 11007 | ULTRA-D PINK | 11008 | ULTRA-D ORANGE | 11009 | ULTRA-D AQUA BLUE | 11010 | ULTRA-D GREY | 11011 | ULTRA-D CAMO | 11012 | ULTRA-D FLUORESCENT YELLOW |
| 11013 | ULTRA-D FLUORESCENT GREEN | 11014 | ULTRA-D FLUORESCENT PINK | 11015 | ULTRA-D TREE | 11016 | ULTRA-D CHAMPION | | | | |

AUTO RETURN BUCKLE-INTRODUCTION



- 1** Ultralight Patented Auto Return aluminum rotary buckle.217g
- 2** Ergonomic T bar
- 3** Accept brand customization (OEM)
- 4** FIA 8853-2016 Standards compliant
- 5** Prevent accidental release
- 6** Quick release with spring ejectors

PATENT



- PAT. 3197144
- PAT. Nr.202015100721.3
- PAT. M583217
- PAT. D208908
- PAT. D213540
- PAT. No 008367833-0001

2" SUPERFAST ADJUSTER-INTRODUCTION



- Exclusive new design patent.
- Handle adjusters can help drivers quickly and easy adjust.
- Superfast adjuster for 2" width webbing.
- Lap strap use superfast tongue adjuster is convenient than general adjuster.

PATENT



- PAT. D207194
- PAT. M593204
- PAT. No 007406004-0001

SPORT PLUS



MANUFACTURER: TBRACING
MODEL: SPORT PLUS
HOM. NO: SH.059.19-T-6
FIA STANDARD: 8853-2016

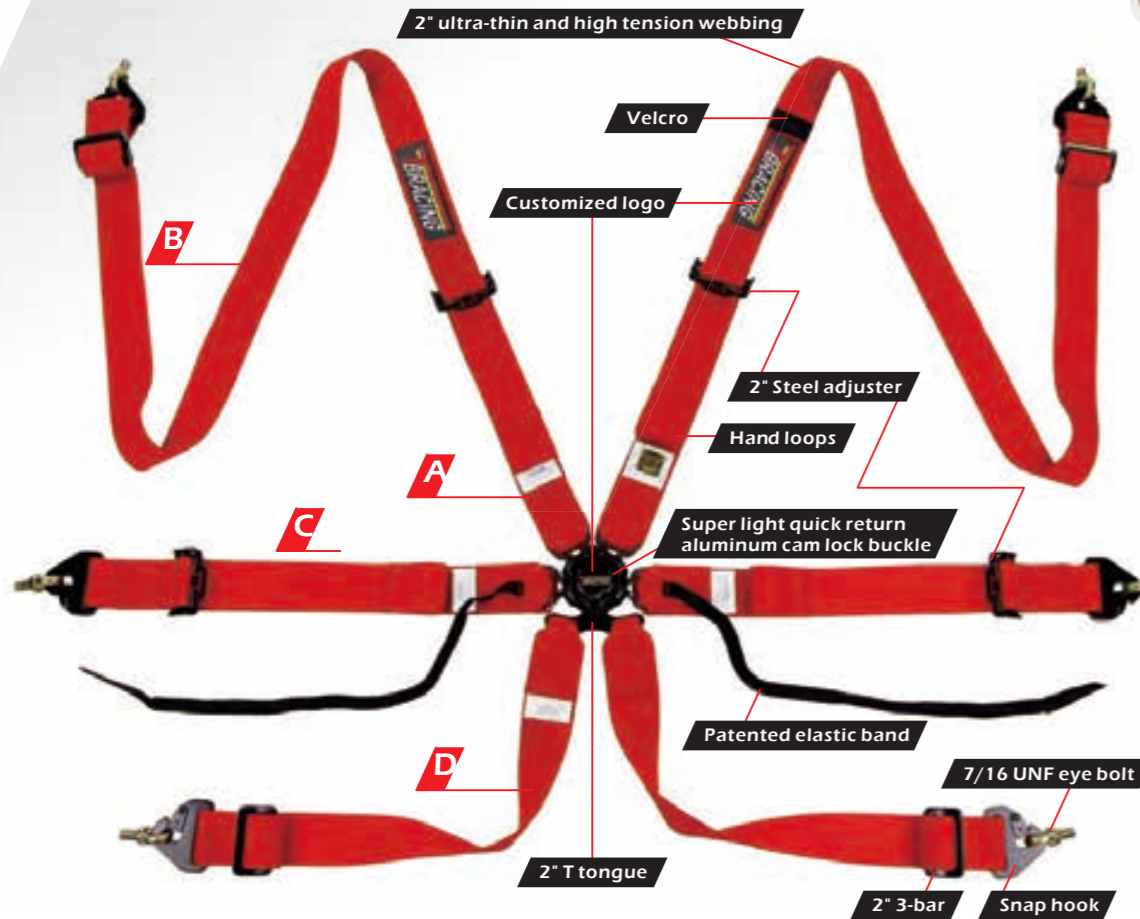

ITEM : SPORT PLUS

- FIA approved 8853-2016
- Add the patented elastic band, which fix the webbing on both sides of the racing seat.
- Using the latest light-weight webbing, light-weight steel adjusters for a smoother faster and secure adjustment on the shoulder and lap belts.
- Ultra-thin and high tension webbing with all 2 inches (50mm).
- Securing Velcro on shoulder belts.
- Ergonomically T-tongue designed.
- Delivered with 7/16 UNF eye bolts.
- Grab loops in the sewing structure even when wearing racing gloves.

STANDARD MEASURES

- A** 500mm **B** 1400mm **C** 700mm
- D** 600mm **GROSS WEIGHT** 2.28KG

STANDARD COLORS

- 60001 SPORT PLUS BLACK 60002 SPORT PLUS RED 60003 SPORT PLUS BLUE 60004 SPORT PLUS YELLOW 60005 SPORT PLUS GREEN 60006 SPORT PLUS PURPLE
- 60007 SPORT PLUS PINK 60008 SPORT PLUS ORANGE 60009 SPORT PLUS AQUA BLUE 60010 SPORT PLUS GREY 60011 SPORT PLUS CAMO 60012 SPORT PLUS FLUORESCENT YELLOW
- 60013 SPORT PLUS FLUORESCENT GREEN 60014 SPORT PLUS FLUORESCENT PINK 60015 SPORT PLUS TREE 60016 SPORT PLUS CHAMPION

SPORT PLUS FEATURES

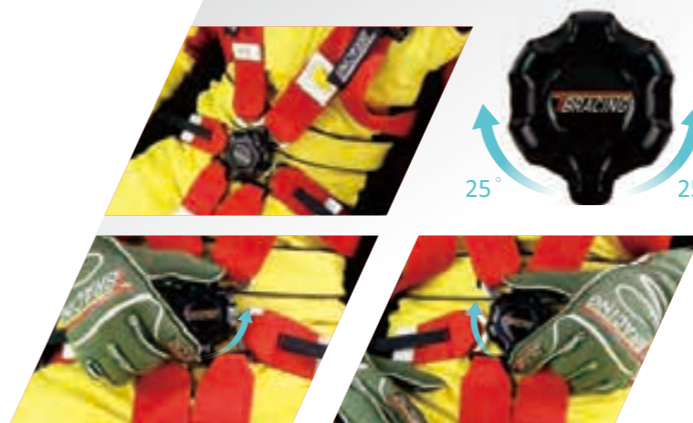

When the driver turn away to release position, lever will be auto return to close position. This is humanitarian design.

TBRACING design the most safety buckle, buckle's lever with slipping protection device (positive and negative 25 degrees) to prevent accidental switch !!



Pull velcro on shoulder belt adjusters can help drivers quickly adjust.



It's easy for using hand loops on the belts to adjust.

SCHEMATIC DIAGRAM

Quick release elastic band device, when drivers release the AR buckle, lap straps will quickly release out the racing seat and fix to the seat edge. For any event which need to change the driver is quite convenient and time saving.

PATENT



- PAT. M563376
- PAT. No 007451992-0001



Fixed to the eyebolt



MANUFACTURER: TBRACING
MODEL: SPORT PLUS
HOM. NO: SH.059.19-T-6
FIA STANDARD: 8853-2016

SPORT PLUS 2

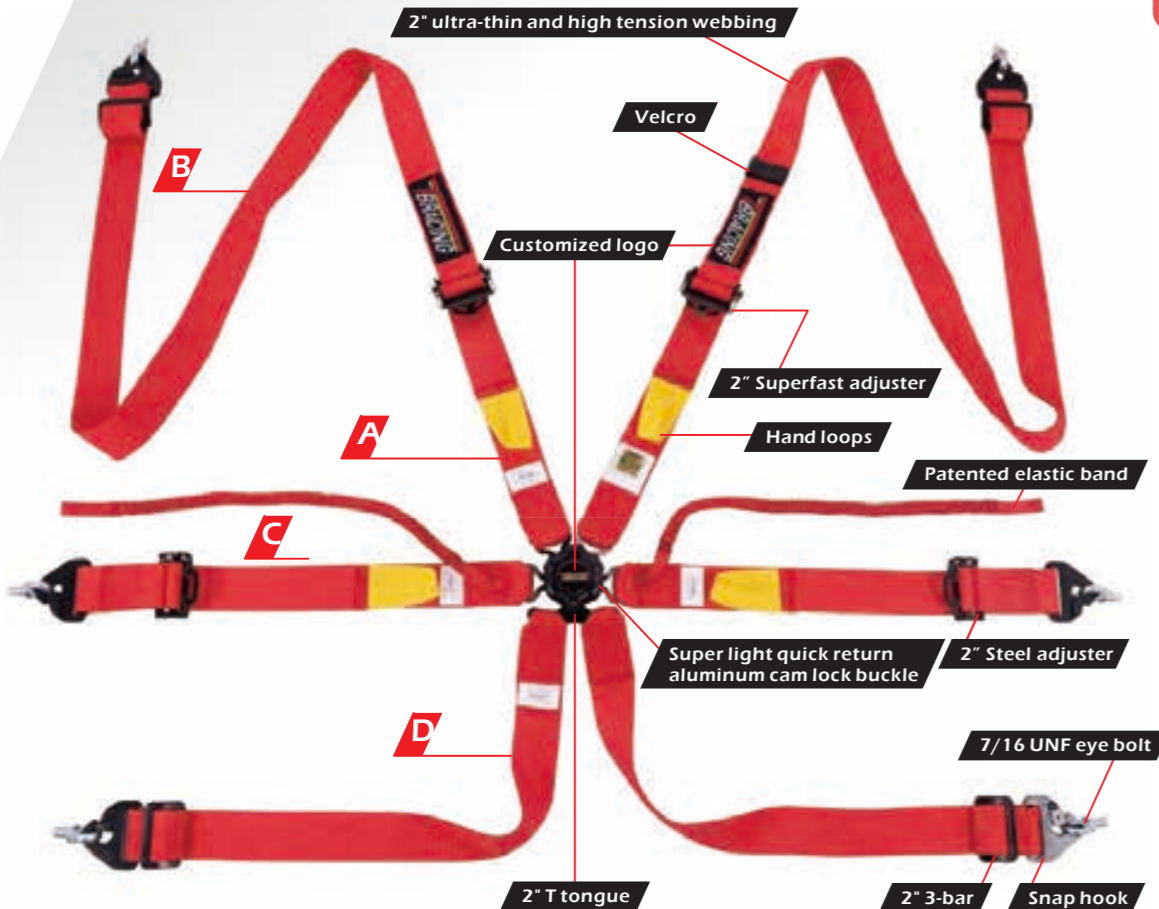

ITEM : SPORT PLUS 2

- FIA approved 8853-2016
- **NEW patent 2" superfast adjuster on the shoulder.**
- **Add the patented elastic band, which help the belts quick release, and easy let driver get in the seat.**
- Using the latest lightweight webbing, lightweight steel adjusters for a smoother faster and secure adjustment on the lap belts.
- Ultra-thin and high tension webbing with all 2 inches (50mm)
- Securing Velcro on shoulder belts.
- Ergonomically T-tongue designed.
- Delivered with 7/16 UNF eye bolts.
- Grab loops in the sewing structure on the shoulder and lap side.

STANDARD MEASURES

- A** 500mm
- B** 1400mm
- C** 700mm
- D** 600mm
- GROSS WEIGHT** 2.15KG

STANDARD COLORS

- 66001 SPORT PLUS 2 BLACK
- 66002 SPORT PLUS 2 RED
- 66003 SPORT PLUS 2 BLUE
- 66004 SPORT PLUS 2 YELLOW
- 66005 SPORT PLUS 2 GREEN
- 66006 SPORT PLUS 2 PURPLE
- 66007 SPORT PLUS 2 PINK
- 66008 SPORT PLUS 2 ORANGE
- 66009 SPORT PLUS 2 AQUA BLUE
- 66010 SPORT PLUS 2 GREY
- 66011 SPORT PLUS 2 CAMO
- 66012 SPORT PLUS 2 FLUORESCENT YELLOW
- 66013 SPORT PLUS 2 FLUORESCENT GREEN
- 66014 SPORT PLUS 2 FLUORESCENT PINK
- 66015 SPORT PLUS 2 TREE
- 66016 SPORT PLUS 2 CHAMPION



MANUFACTURER: TBRACING
MODEL: SPORT
HOM. NO: SH.002.16-T-6
FIA STANDARD: 8853-2016

SPORT

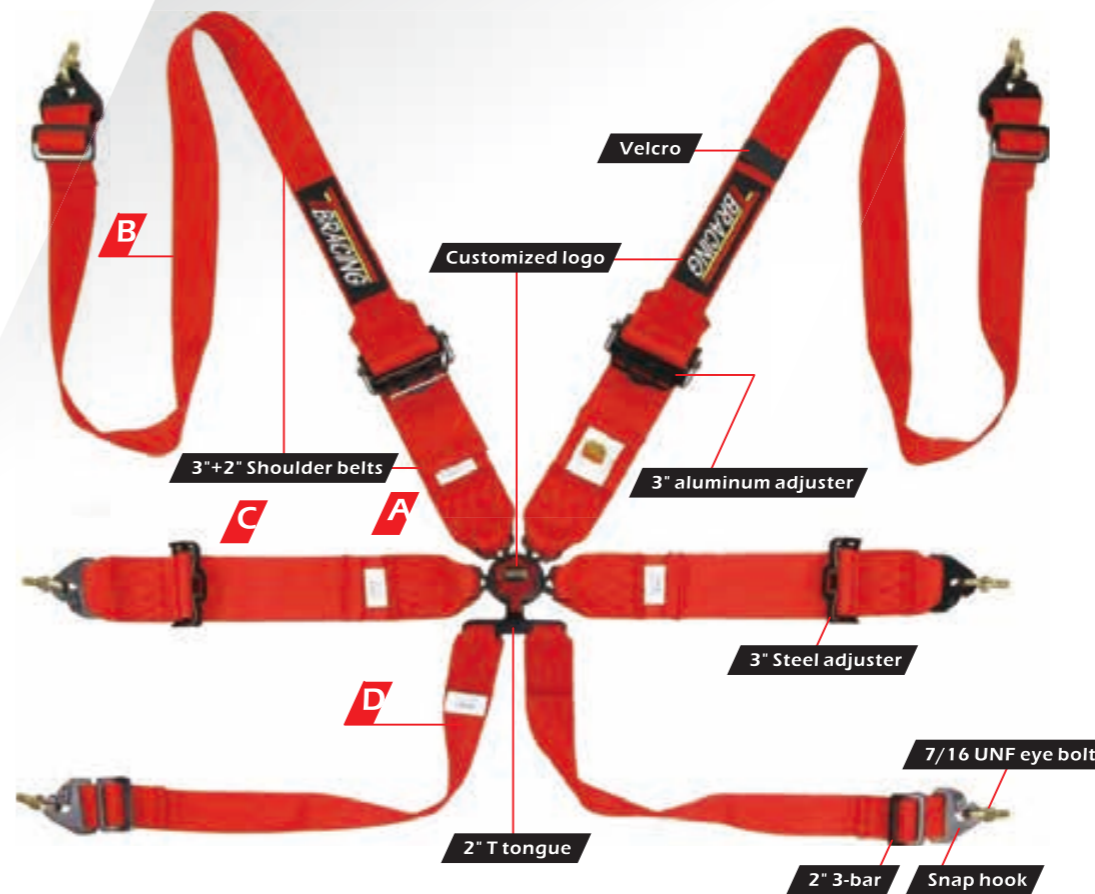

ITEM : SPORT

- FIA approved 8853-2016
- Lightweight aluminum cam lock buckle.
- 2"/3" shoulder belts (wrap/snap hook fitting) with aluminum adjusters.
- Securing Velcro on shoulder belts.
- 3" lap belts with steel adjusters for pull-up system and T-bar crutch straps.
- Delivered with 7/16 UNF eye bolts.

STANDARD MEASURES

- A** 350mm
- B** 1450mm
- C** 600mm
- D** 650mm
- GROSS WEIGHT** 2.46KG

STANDARD COLORS

- 61001 SPORT BLACK
- 61002 SPORT RED
- 61003 SPORT BLUE
- 61004 SPORT YELLOW
- 61005 SPORT GREEN
- 61006 SPORT PURPLE
- 61007 SPORT PINK
- 61008 SPORT ORANGE
- 61009 SPORT AQUA BLUE
- 61010 SPORT GREY
- 61011 SPORT CAMO
- 61012 SPORT FLUORESCENT YELLOW
- 61013 SPORT FLUORESCENT GREEN
- 61014 SPORT FLUORESCENT PINK
- 61015 SPORT TREE
- 61016 SPORT CHAMPION



MANUFACTURER: TBRACING
 MODEL: SPORT PLUS
 HOM. NO: SH.059.19-T-6
 FIA STANDARD: 8853-2016

SPORT PLUS 3

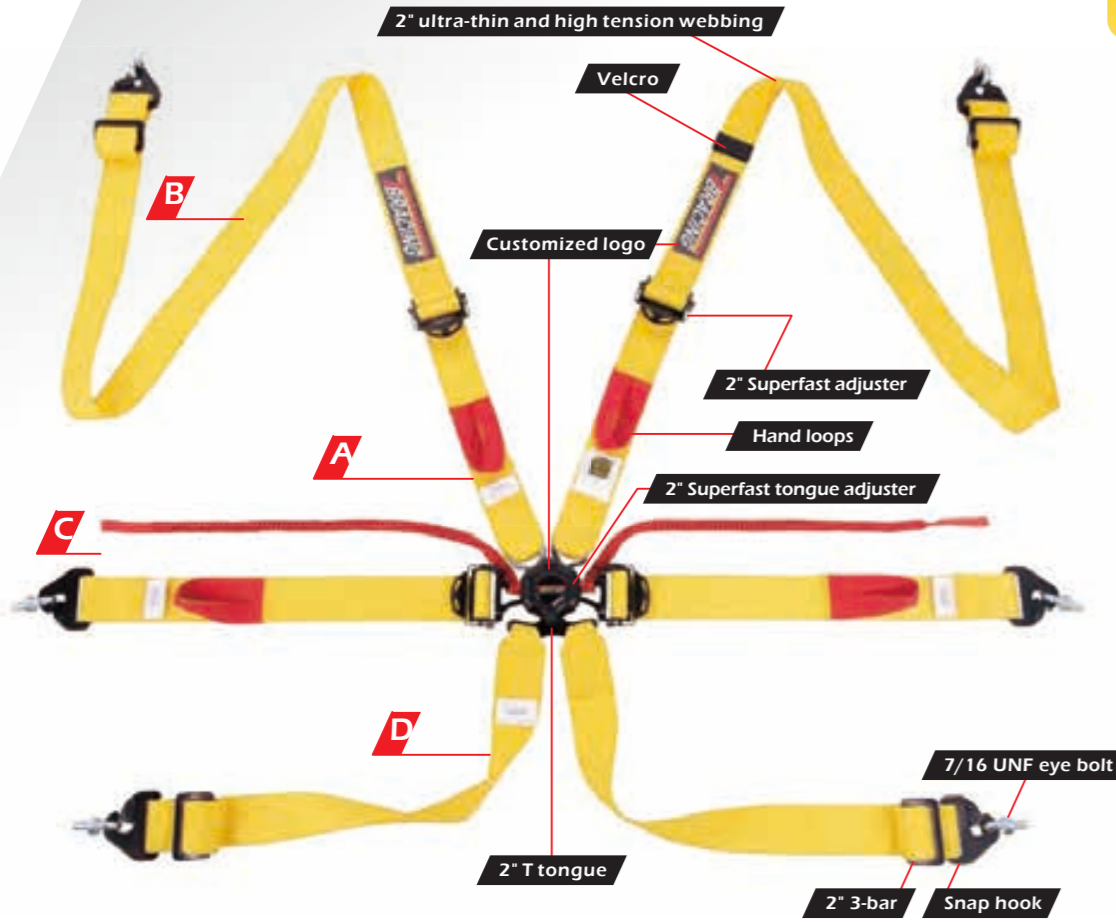

ITEM : SPORT PLUS 3

- FIA approved 8853-2016
- Superlight printing logo
- Add the patented elastic band, which help the belts quick release, and easy let driver get in the seat.
- Pull down systems.
- NEW patent 2" superfast adjuster on the shoulder.
- NEW patent 2" superfast tongue adjuster on the lap strap.
- Using the latest lightweight webbing, lightweight steel adjusters for a smoother faster and secure adjustment on the lap belts.
- Ultra-thin and high tension webbing with all 2 inches (50mm)
- Securing Velcro on shoulder belts.
- Ergonomically T-tongue designed.
- Delivered with 7/16 UNF eye bolts.
- Grab loops in the sewing structure on the shoulder and lap side.

STANDARD MEASURES

A 500mm	B 1400mm	C 700mm
D 600mm	GROSS WEIGHT 2.35KG	

STANDARD COLORS

- 67001 SPORT PLUS 3 BLACK 67002 SPORT PLUS 3 RED 67003 SPORT PLUS 3 BLUE 67004 SPORT PLUS 3 YELLOW 67005 SPORT PLUS 3 GREEN 67006 SPORT PLUS 3 PURPLE
 67007 SPORT PLUS 2 PINK 67008 SPORT PLUS 2 ORANGE 67009 SPORT PLUS 3 AQUA BLUE 67010 SPORT PLUS 3 GREY 67011 SPORT PLUS 3 CAMO 67012 SPORT PLUS 3 FLUORESCENT YELLOW
 67013 SPORT PLUS 2 FLUORESCENT GREEN 67014 SPORT PLUS 3 FLUORESCENT PINK 67015 SPORT PLUS 3 TREE 67016 SPORT PLUS 3 CHAMPION

SPORT PLUS 3-FEATURES

ULTRA-LIGHT



HIGH-INTENSITIVE



HIGH-POPULAR



HIGH-QUALITY

The preferred racing harness for World Rally Championship, Rally Racing, Drag Racing, Formula Car, Touring Car Racing, Le Mans Prototype Racing.

SPORT PLUS 4



MANUFACTURER: TBRACING
MODEL: SPORT PLUS
HOM. NO: SH.059.19-T-6
FIA STANDARD: 8853-2016



ITEM : SPORT PLUS 4

- FIA approved 8853-2016
- New printing webbing with Ultra-thin and high tension webbing.
- Add the patented elastic band, which help the belts quick release, and easy let driver get in the seat.
- 3" Ultra-light adjuster on the shoulder
- Pull down systems
- NEW patent 2"superfast tongue adjuster on the lap strap.
- Securing Velcro on shoulder belts.
- Ergonomically T-tongue designed.
- Delivered with bolt-in attachments.
- Grab loops in the sewing structure on the shoulder and lap side.

STANDARD MEASURES

- A** 350mm
- B** 1350mm
- C** 700mm
- D** 600mm
- GROSS WEIGHT** 2.30KG

STANDARD COLORS

- 12001 SPORT PLUS 4 BLACK
- 12002 SPORT PLUS 4 RED
- 12003 SPORT PLUS 4 BLUE
- 12004 SPORT PLUS 4 YELLOW
- 12005 SPORT PLUS 4 GREEN
- 12006 SPORT PLUS 4 PURPLE
- 12007 SPORT PLUS 4 PINK
- 12008 SPORT PLUS 4 ORANGE
- 12009 SPORT PLUS 4 AQUA BLUE
- 12010 SPORT PLUS 4 GREY
- 12011 SPORT PLUS 4 CAMO
- 12012 SPORT PLUS 4 FLUORESCENT YELLOW
- 12013 SPORT PLUS 4 FLUORESCENT GREEN
- 12014 SPORT PLUS 4 FLUORESCENT PINK
- 12015 SPORT PLUS 4 TREE
- 12016 SPORT PLUS 4 CHAMPION

SPORT PLUS 5



MANUFACTURER: TBRACING
MODEL: SPORT PLUS
HOM. NO: SH.059.19-T-6
FIA STANDARD: 8853-2016



ITEM : SPORT PLUS 5

- FIA approved 8853-2016
- New printing webbing with Ultra-thin and high tension webbing.
- Add the patented elastic band, which help the belts quick release, and easy let driver get in the seat.
- 3" Ultra-light adjuster on the shoulder
- Pull up systems
- Securing Velcro on shoulder belts.
- Ergonomically T-tongue designed.
- Delivered with bolt-in attachments.
- Grab loops in the sewing structure on the shoulder and lap side.

STANDARD MEASURES

- A** 350mm
- B** 1350mm
- C** 700mm
- D** 600mm
- GROSS WEIGHT** 2.30KG

STANDARD COLORS

- 13001 SPORT PLUS 5 BLACK
- 13002 SPORT PLUS 5 RED
- 13003 SPORT PLUS 5 BLUE
- 13004 SPORT PLUS 5 YELLOW
- 13005 SPORT PLUS 5 GREEN
- 13006 SPORT PLUS 5 PURPLE
- 13007 SPORT PLUS 5 PINK
- 13008 SPORT PLUS 5 ORANGE
- 13009 SPORT PLUS 5 AQUA BLUE
- 13010 SPORT PLUS 5 GREY
- 13011 SPORT PLUS 5 CAMO
- 13012 SPORT PLUS 5 FLUORESCENT YELLOW
- 13013 SPORT PLUS 5 FLUORESCENT GREEN
- 13014 SPORT PLUS 5 FLUORESCENT PINK
- 13015 SPORT PLUS 5 TREE
- 13016 SPORT PLUS 5 CHAMPION

SPORT-S



MANUFACTURER: TBRACING
MODEL: SPORT
HOM. NO: SH.002.16-T-6
FIA STANDARD: 8853-2016



SFI 16.1 certified.



ITEM : SPORT-S

- FIA approved 8853-2016 and SFI Spec 16.1 Certified.
- Light weight aluminum cam lock buckle.
- 2"/3" shoulder straps (FHR systems) with steel adjusters.
- 3" pelvic straps with steel adjusters pull-up.
- 2" crotch straps with T tongue.
- Snap hook with UNF 7/16 eye bolt screw and safety pin.
- Securing Velcro on shoulder belts.

STANDARD MEASURES

A 350mm **B** 1350mm **C** 600mm
D 550mm **GROSS WEIGHT** 2.54KG

STANDARD COLORS

- | | | | | | |
|---------------------------------|--------------------------------|-------------------------|------------------------|---------------------|----------------------------------|
| 62001 SPORT-S BLACK | 62002 SPORT-S RED | 62003 SPORT-S BLUE | 62004 SPORT-S YELLOW | 62005 SPORT-S GREEN | 62006 SPORT-S PURPLE |
| 62007 SPORT-S PINK | 62008 SPORT-S ORANGE | 62009 SPORT-S AQUA BLUE | 62010 SPORT-S GREY | 62011 SPORT-S CAMO | 62012 SPORT-S FLUORESCENT YELLOW |
| 62013 SPORT-S FLUORESCENT GREEN | 62014 SPORT-S FLUORESCENT PINK | 62015 SPORT-S TREE | 62016 SPORT-S CHAMPION | | |

ECO



MANUFACTURER: TBRACING
MODEL: SPORT
HOM. NO: SH.002.16-T-6
FIA STANDARD: 8853-2016

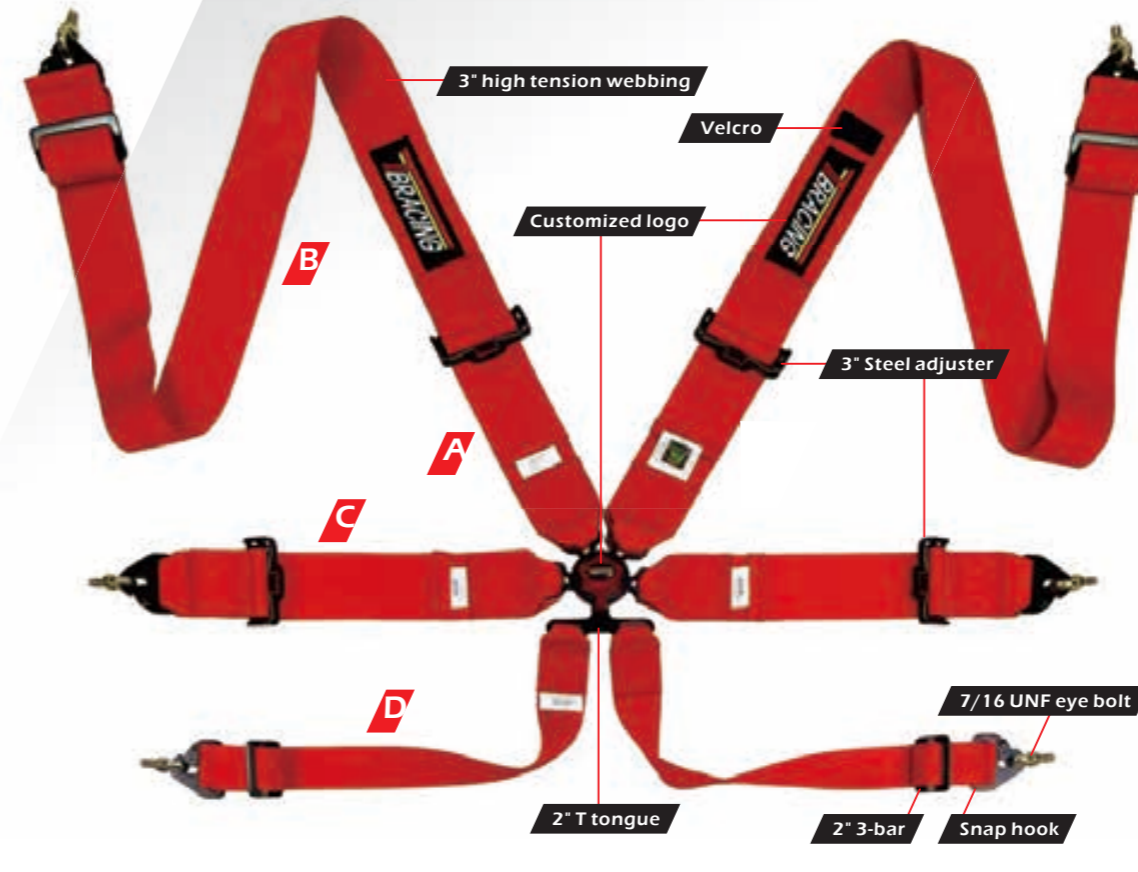

ITEM : ECO

- FIA approved 8853-2016
- Lightweight aluminum cam lock buckle.
- 3" shoulder straps with steel adjusters.
- 3" pelvic straps with steel adjusters pull-up.
- 2" crotch straps with T tongue.
- Snap hook with UNF 7/16 eye bolt screw and safety pin.
- Securing Velcro on shoulder belts.

STANDARD MEASURES

A 350mm **B** 1350mm **C** 600mm
D 550mm **GROSS WEIGHT** 2.68KG

STANDARD COLORS

- | | | | | | |
|-----------------------------|----------------------------|---------------------|--------------------|-----------------|------------------------------|
| 63001 ECO BLACK | 63002 ECO RED | 63003 ECO BLUE | 63004 ECO YELLOW | 63005 ECO GREEN | 63006 ECO PURPLE |
| 63007 ECO PINK | 63008 ECO ORANGE | 63009 ECO AQUA BLUE | 63010 ECO GREY | 63011 ECO CAMO | 63012 ECO FLUORESCENT YELLOW |
| 63013 ECO FLUORESCENT GREEN | 63014 ECO FLUORESCENT PINK | 63015 ECO TREE | 63016 ECO CHAMPION | | |

ECO-A



MANUFACTURER: TBRACING
MODEL: SPORT
HOM. NO: SH.002.16-T-6
FIA STANDARD: 8853-2016



ITEM : ECO-A

- FIA approved 8853-2016
- Lightweight aluminum cam lock buckle.
- 3" shoulder straps with aluminum adjusters.
- 3" pelvic straps with steel adjusters pull-up.
- 2" crotch straps with T tongue.
- Snap hook with UNF 7/16 eye bolt screw and safety pin.
- Securing Velcro on shoulder belts.

STANDARD MEASURES

A 350mm **B** 1350mm **C** 600mm
D 550mm **GROSS WEIGHT** 2.62KG

STANDARD COLORS

- | | | | | | |
|-------------------------------|------------------------------|-----------------------|----------------------|-------------------|--------------------------------|
| 64001 ECO-A BLACK | 64002 ECO-A RED | 64003 ECO-A BLUE | 64004 ECO-A YELLOW | 64005 ECO-A GREEN | 64006 ECO-A PURPLE |
| 64007 ECO-A PINK | 64008 ECO-A ORANGE | 64009 ECO-A AQUA BLUE | 64010 ECO-A GREY | 64011 ECO-A CAMO | 64012 ECO-A FLUORESCENT YELLOW |
| 64013 ECO-A FLUORESCENT GREEN | 64014 ECO-A FLUORESCENT PINK | 64015 ECO-A TREE | 64016 ECO-A CHAMPION | | |

ECO-D



MANUFACTURER: TBRACING
MODEL: SPORT
HOM. NO: SH.002.16-T-6
FIA STANDARD: 8853-2016



ITEM : ECO-D

- FIA approved 8853-2016
- Pull down systems
- Lightweight aluminum cam lock buckle.
- 3" shoulder straps with steel adjusters.
- 3" pelvic straps with steel adjusters pull-up.
- 2" crotch straps with T tongue.
- Snap hook with UNF 7/16 eyebolt screw and safety pin.
- Securing Velcro on shoulder belts.

STANDARD MEASURES

A 350mm **B** 1350mm **C** 600mm
D 550mm **GROSS WEIGHT** 2.68KG

STANDARD COLORS

- | | | | | | |
|-------------------------------|------------------------------|-----------------------|----------------------|-------------------|--------------------------------|
| 69001 ECO-D BLACK | 69002 ECO-D RED | 69003 ECO-D BLUE | 69004 ECO-D YELLOW | 69005 ECO-D GREEN | 69006 ECO-D PURPLE |
| 69007 ECO-D PINK | 69008 ECO-D ORANGE | 69009 ECO-D AQUA BLUE | 69010 ECO-D GREY | 69011 ECO-D CAMO | 69012 ECO-D FLUORESCENT YELLOW |
| 69013 ECO-D FLUORESCENT GREEN | 69014 ECO-D FLUORESCENT PINK | 69015 ECO-D TREE | 69016 ECO-D CHAMPION | | |

SHOULDER LOGO



1 PRINTING LOGO



2 WOVEN LOGO



3 DIMENSIONAL EMBROIDERY LOGO

SHOULDER BELT



1 VELCRO



2 1" LOOP STRAPS



option color

HAND LOOP



1 HAND LOOPS



option color



2 1" PULL STRAPS



option color

STANDARD COLORS



SF-501



SFI 16.1 certified.



ITEM : SF-501

- SFI Spec 16.1 Driver Restraint Assemblies Certified.
- Indications: Jr. Dragsters and Quarter Midgets.
- Features polyester construction for maximum protection.
- 3" shoulder straps with steel adjusting devices / 3" pelvic straps with steel adjusting devices / 2" crotch straps with tongue.
- Delivered with bolt-in attachment or snap in with 7/16 UNF eye bolts.
- Adjuster include anti-slip spring.
- Pull-down systems.

STANDARD MEASURES

A 1510mm **B** 400mm **C** 650mm
D 600mm **GROSS WEIGHT** 2.84KG



STANDARD COLORS

- | | | | | | |
|-------------------------------|------------------------------|-----------------------|----------------------|-------------------|--------------------------------|
| 50001 SF501 BLACK | 50002 SF501 RED | 50003 SF501 BLUE | 50004 SF501 YELLOW | 50005 SF501 GREEN | 50006 SF501 PURPLE |
| 50007 SF501 PINK | 50008 SF501 ORANGE | 50009 SF501 AQUA BLUE | 50010 SF501 GREY | 50011 SF501 CAMO | 50012 SF501 FLUORESCENT YELLOW |
| 50013 SF501 FLUORESCENT GREEN | 50014 SF501 FLUORESCENT PINK | 50015 SF501 TREE | 50016 SF501 CHAMPION | | |

SF-502



SFI 16.1 certified.



ITEM : SF-502

- SFI Spec 16.1 Driver Restraint Assemblies Certified.
- Indications: NHRA or Drag Racing.
- Features polyester construction for maximum protection.
- 3" shoulder straps with steel adjusting devices / 3" pelvic straps with steel adjusting devices / 2" crotch straps with tongue.
- Delivered with bolt-in attachment or snap in with 7/16 UNF eye bolts.
- Adjuster include anti-slip spring.
- Pull-down systems.

STANDARD MEASURES

A 1510mm **B** 380mm **C** 1550mm
D 600mm **GROSS WEIGHT** 2.96KG



STANDARD COLORS

- | | | | | | |
|-------------------------------|------------------------------|-----------------------|----------------------|-------------------|--------------------------------|
| 51001 SF502 BLACK | 51002 SF502 RED | 51003 SF502 BLUE | 51004 SF502 YELLOW | 51005 SF502 GREEN | 51006 SF502 PURPLE |
| 51007 SF502 PINK | 51008 SF502 ORANGE | 51009 SF502 AQUA BLUE | 51010 SF502 GREY | 51011 SF502 CAMO | 51012 SF502 FLUORESCENT YELLOW |
| 51013 SF502 FLUORESCENT GREEN | 51014 SF502 FLUORESCENT PINK | 51015 SF502 TREE | 51016 SF502 CHAMPION | | |

SF-601

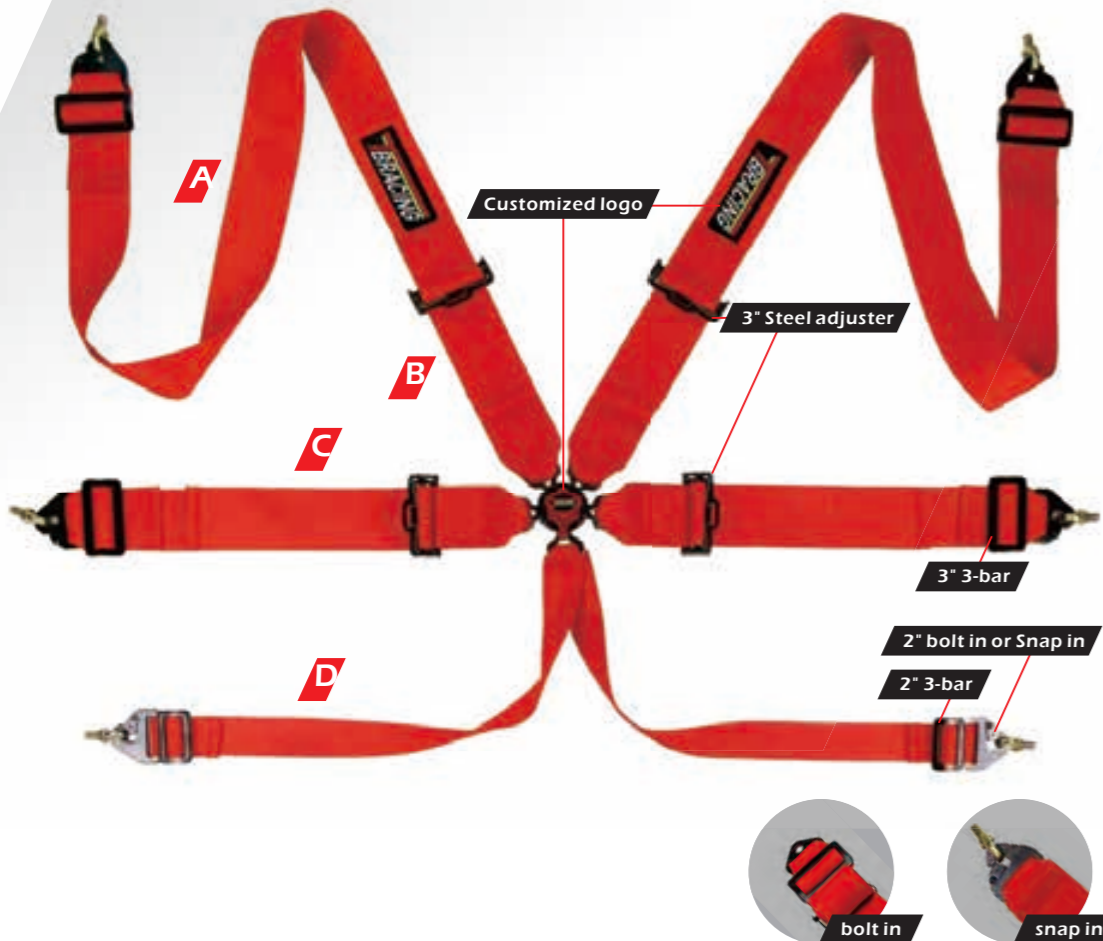

ITEM : SF-601

- SFI Spec 16.1 Driver Restraint Assemblies Certified.
- Lightweight aluminum alloy cam buckle.
- Features polyester construction for maximum protection.
- 3" shoulder straps with steel adjusting devices / 3" pelvic straps with steel adjusting devices / 2" crotch straps with tongue.
- Delivered with bolt-in attachment or snap in with 7/16 UNF eye bolts.
- Pull-down systems.

STANDARD MEASURES

A	1310mm	B	380mm	C	820mm
D	1350mm	GROSS WEIGHT	2.88KG		

STANDARD COLORS

65001 SF601 BLACK	65002 SF601 RED	65003 SF601 BLUE	65004 SF601 YELLOW	65005 SF601 GREEN	65006 SF601 PURPLE
65007 SF601 PINK	65008 SF601 ORANGE	65009 SF601 AQUA BLUE	65010 SF601 GREY	65011 SF601 CAMO	65012 SF601 FLUORESCENT YELLOW
65013 SF601 FLUORESCENT GREEN	65014 SF601 FLUORESCENT PINK	65015 SF601 TREE	65016 SF601 CHAMPION		

SF-602

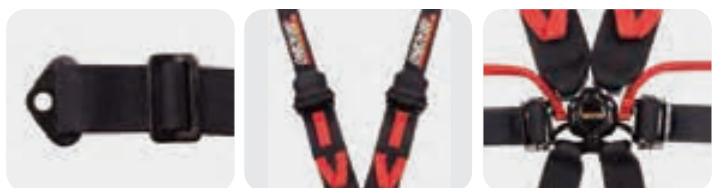

ITEM : SF-602

- SFI Specification 16.5 Stock Car Driver Restraint Assemblies Certified.
- Add the patented elastic band, which help the belts quick release, and easy let driver get in the seat.
- 3" Ultra-light adjuster on the shoulder.
- Pull down systems.
- NEW patent 2" superfast tongue adjuster on the lap strap.
- Securing Velcro on shoulder belts.
- Ergonomically T-tongue designed.
- Delivered with bolt-in attachments.
- 1" Grab loops in the sewing structure on the shoulder and lap side.

STANDARD MEASURES

A	1350mm	B	350mm	C	700mm
D	600mm	GROSS WEIGHT	2.24KG		

STANDARD COLORS

68001 SF602 BLACK	68002 SF602 RED	68003 SF602 BLUE	68004 SF602 YELLOW	68005 SF602 GREEN	68006 SF602 PURPLE
68007 SF602 PINK	68008 SF602 ORANGE	68009 SF602 AQUA BLUE	68010 SF602 GREY	68011 SF602 CAMO	68012 SF602 FLUORESCENT YELLOW
68013 SF602 FLUORESCENT GREEN	68014 SF602 FLUORESCENT PINK	68015 SF602 TREE	68016 SF602 CHAMPION		

TUN-402



ITEM : TUN-402

- 4 point harness with 2 inch belts.
- Easy to use automotive push button style latch system.
- The shoulder pads that stop chaffing on the neck and adds extra comfort.
- Easy installation using seat belt mounting points and black hardware.
- Pull- down systems.

STANDARD MEASURES

A 740mm **B** 580 mm **C** 880mm
GROSS WEIGHT 1.66KG

STANDARD COLORS

- 40001 TUN402 BLACK
- 40002 TUN402 RED
- 40003 TUN402 BLUE
- 40004 TUN402 YELLOW
- 40005 TUN402 GREEN
- 40006 TUN402 PURPLE
- 40007 TUN402 PINK
- 40008 TUN402 ORANGE
- 40009 TUN402 AQUA BLUE
- 40010 TUN402 GREY
- 40011 TUN402 CAMO
- 40012 TUN402 FLUORESCENT YELLOW
- 40013 TUN402 FLUORESCENT GREEN
- 40014 TUN402 FLUORESCENT PINK
- 40015 TUN402 TREE
- 40016 TUN402 CHAMPION

TUN-402CG



ITEM : TUN-402CG

- 4 point harness with 2 inch belts. Auto buckle
- Easy to use automotive push button style latch system.
- Remove the GEL padding and throw them in the wash so they are fresh for your next ride.
- New technology: Cooling GEL padding , 0 degrees without freezing, detachable, extremely comfortable body feeling
- Easy installation using seat belt mounting points and black hardware.
- Pull- down systems.

STANDARD MEASURES

A 740mm **B** 580 mm **C** 880mm
GROSS WEIGHT 2.26KG

STANDARD COLORS

- 46001 TUN402CG BLACK
- 46002 TUN402CG RED
- 46003 TUN402CG BLUE
- 46004 TUN402CG YELLOW
- 46005 TUN402CG GREEN
- 46006 TUN402CG PURPLE
- 46007 TUN402CG PINK
- 46008 TUN402CG ORANGE
- 46009 TUN402CG AQUA BLUE
- 46010 TUN402CG GREY
- 46011 TUN402CG CAMO
- 46012 TUN402CG FLUORESCENT YELLOW
- 46013 TUN402CG FLUORESCENT GREEN
- 46014 TUN402CG FLUORESCENT PINK
- 46015 TUN402CG TREE
- 46016 TUN402CG CHAMPION

SF-401

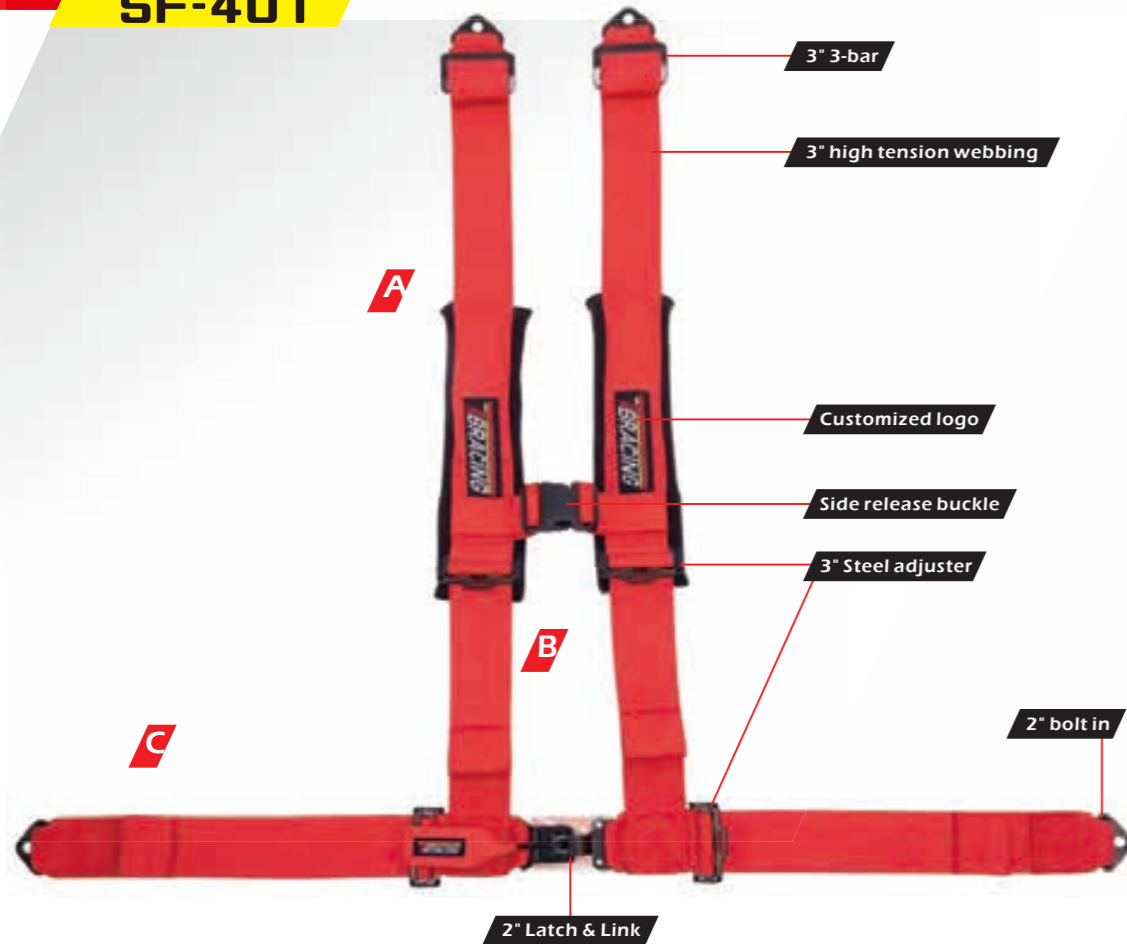

ITEM : SF-401

- Indications: UTV or other off-road vehicle-not replacement for FMVSS 209 restraints.
- Easy in and easy out latch and link system
- Sewn in pads AND Removable sternum strap
- Features polyester construction for maximum protection
- 3" shoulder straps with steel adjusting devices / 3" pelvic straps with steel adjusting devices.
- Clip-in and Bolt-in OPTIONS AVAILABLE

STANDARD MEASURES

A 700mm **B** 550mm **C** 880mm

GROSS WEIGHT 2.44KG

STANDARD COLORS

- | | | | | | |
|-------------------------------|------------------------------|-----------------------|----------------------|-------------------|--------------------------------|
| 41001 SF401 BLACK | 41002 SF401 RED | 41003 SF401 BLUE | 41004 SF401 YELLOW | 41005 SF401 GREEN | 41006 SF401 PURPLE |
| 41007 SF401 PINK | 41008 SF401 ORANGE | 41009 SF401 AQUA BLUE | 41010 SF401 GREY | 41011 SF401 CAMO | 41012 SF401 FLUORESCENT YELLOW |
| 41013 SF401 FLUORESCENT GREEN | 41014 SF401 FLUORESCENT PINK | 41015 SF401 TREE | 41016 SF401 CHAMPION | | |

OR-401



ITEM : OR-401

- Indications: UTV or other off-road vehicle-not replacement for FMVSS 209 restraints.
- Easy in and easy out latch and link system
- Sewn in pads AND Removable sternum strap
- Grab loops in the sewing structure
- Features polyester construction for maximum protection
- 3" shoulder straps with aluminum adjusting devices / 3" pelvic straps with steel adjusting devices.
- Clip-in and Bolt-in OPTIONS AVAILABLE

STANDARD MEASURES

A 700mm **B** 550mm **C** 880mm

GROSS WEIGHT 2.36KG

STANDARD COLORS

- | | | | | | |
|-------------------------------|------------------------------|-----------------------|----------------------|-------------------|--------------------------------|
| 42001 OR401 BLACK | 42002 OR401 RED | 42003 OR401 BLUE | 42004 OR401 YELLOW | 42005 OR401 GREEN | 42006 OR401 PURPLE |
| 42007 OR401 PINK | 42008 OR401 ORANGE | 42009 OR401 AQUA BLUE | 42010 OR401 GREY | 42011 OR401 CAMO | 42012 OR401 FLUORESCENT YELLOW |
| 42013 OR401 FLUORESCENT GREEN | 42014 OR401 FLUORESCENT PINK | 42015 OR401 TREE | 42016 OR401 CHAMPION | | |

OR-402



ITEM : OR-402

- Indications: UTV or other off-road vehicle-not replacement for FMVSS 209 restraints.
- Easy in and easy out latch and link system
- Sewn in pads AND Removable sternum strap
- Grab loops in the sewing structure
- Features polyester construction for maximum protection
- 2" shoulder straps with steel adjusting devices / 2" pelvic straps with steel adjusting devices.
- Clip-in and Bolt-in OPTIONS AVAILABLE

STANDARD MEASURES

A 700mm **B** 550mm **C** 880mm

GROSS WEIGHT 1.76KG

STANDARD COLORS

- 45001 OR402 BLACK 45002 OR402 RED 45003 OR402 BLUE 45004 OR402 YELLOW 45005 OR402 GREEN 45006 OR402 PURPLE
 45007 OR402 PINK 45008 OR402 ORANGE 45009 OR402 AQUA BLUE 45010 OR402 GREY 45011 OR402 CAMO 45012 OR402 FLUORESCENT YELLOW
 45013 OR402 FLUORESCENT GREEN 45014 OR402 FLUORESCENT PINK 45015 OR402 TREE 45016 OR402 CHAMPION

OR-501



ITEM : OR-501

- 5 point UTV harness with 2 inch belts
- 2" shoulder straps with steel adjusting devices / 2" pelvic straps with steel adjusting devices / 2" crotch straps with tongue.
- Delivered with bolt-in attachment or snap in with 7/16 UNF eye bolts.
- Easy in and easy out latch and link system
- Sewn in pads AND Removable sternum strap
- Grab loops in the sewing structure

STANDARD MEASURES

A 660mm **B** 630mm **C** 880mm

D 600mm **GROSS WEIGHT** 2.22KG

STANDARD COLORS

- 52001 OR501 BLACK 52002 OR501 RED 52003 OR501 BLUE 52004 OR501 YELLOW 52005 OR501 GREEN 52006 OR501 PURPLE
 52007 OR501 PINK 52008 OR501 ORANGE 52009 OR501 AQUA BLUE 52010 OR501 GREY 52011 OR501 CAMO 52012 OR501 FLUORESCENT YELLOW
 52013 OR501 FLUORESCENT GREEN 52014 OR501 FLUORESCENT PINK 52015 OR501 TREE 52016 OR501 CHAMPION

OR-502



SFI 16.1 certified.



ITEM : OR-502

- 5 point UTV harness with 3 inch belts
- 3" shoulder straps with steel adjusting devices / 3" pelvic straps with steel adjusting devices / 2" crotch straps with tongue.
- Delivered with bolt-in attachment or snap in with 7/16 UNF eye bolts.
- Easy in and easy out latch and link system
- Sewn in pads AND Removable sternum strap
- Grab loops in the sewing structure

STANDARD MEASURES

A 730mm	B 580mm	C 830mm
D 600mm	GROSS WEIGHT 2.84KG	

STANDARD COLORS

- | | | | | | |
|-------------------------------|------------------------------|-----------------------|----------------------|-------------------|--------------------------------|
| 53001 OR502 BLACK | 53002 OR502 RED | 53003 OR502 BLUE | 53004 OR502 YELLOW | 53005 OR502 GREEN | 53006 OR502 PURPLE |
| 53007 OR502 PINK | 53008 OR502 ORANGE | 53009 OR502 AQUA BLUE | 53010 OR502 GREY | 53011 OR502 CAMO | 53012 OR502 FLUORESCENT YELLOW |
| 53013 OR502 FLUORESCENT GREEN | 53014 OR502 FLUORESCENT PINK | 53015 OR502 TREE | 53016 OR502 CHAMPION | | |

RM-501



SFI 16.1 certified.



ITEM : RM-501

- SFI Spec 16.1 Driver Restraint Assemblies Certified.
- Indications: Sprint Car, Midget Car, Modifieds
- Features polyester construction for maximum protection.
- Ratchet belts are designed to allow quicker and tighter adjustment of the lap belt for the driver without any assistance.
- Ratchet on left side of 2 inch lap belt with right side of lap belt stationary.
- The ratchet is on the lap belt left side.
- All wrap around ends except the left side of lap belt (ratchet) is bolt-in. (1/4" hand ratchet wrench/tool not included.)

STANDARD MEASURES

A 1510mm	B 400mm	C 650mm
D 600mm	GROSS WEIGHT 2.77KG	

STANDARD COLORS

- | | | | | | |
|-------------------------------|------------------------------|-----------------------|----------------------|-------------------|--------------------------------|
| 54001 RM501 BLACK | 54002 RM501 RED | 54003 RM501 BLUE | 54004 RM501 YELLOW | 54005 RM501 GREEN | 54006 RM501 PURPLE |
| 54007 RM501 PINK | 54008 RM501 ORANGE | 54009 RM501 AQUA BLUE | 54010 RM501 GREY | 54011 RM501 CAMO | 54012 RM501 FLUORESCENT YELLOW |
| 54013 RM501 FLUORESCENT GREEN | 54014 RM501 FLUORESCENT PINK | 54015 RM501 TREE | 54016 RM501 CHAMPION | | |

RM-502



sfi
SFI FOUNDATION INC.
SFI 16.1 certified.



ITEM : RM-502

- SFI Spec 16.1 Driver Restraint Assemblies Certified.
- Indications: Sprint Car, Midget Car, Modifieds
- Features polyester construction for maximum protection.
- Ratchet belts are designed to allow quicker and tighter adjustment of the lap belt for the driver without any assistance.
- Ratchet on left side of 3 inch lap belt with right side of lap belt stationary.
- The ratchet is on the lap belt left side.
- All wrap around ends except the left side of lap belt (ratchet) is bolt-in. (1/4" hand ratchet wrench/tool not included.)

STANDARD MEASURES

A 1510mm **B** 400mm **C** 650mm
D 600mm **GROSS WEIGHT** 2.83KG

STANDARD COLORS

- | | | | | | |
|-------------------------------|------------------------------|-----------------------|----------------------|-------------------|--------------------------------|
| 55001 RM502 BLACK | 55002 RM502 RED | 55003 RM502 BLUE | 55004 RM502 YELLOW | 55005 RM502 GREEN | 55006 RM502 PURPLE |
| 55007 RM502 PINK | 55008 RM502 ORANGE | 55009 RM502 AQUA BLUE | 55010 RM502 GREY | 55011 RM502 CAMO | 55012 RM502 FLUORESCENT YELLOW |
| 55013 RM502 FLUORESCENT GREEN | 55014 RM502 FLUORESCENT PINK | 55015 RM502 TREE | 55016 RM502 CHAMPION | | |

TUN-403



An Emergency Locking Retractor (ELR) is a seat belt retractor that locks only in response to the rapid deceleration of a vehicle or rapid spooling out of the seat belt webbing from the retractor.

ITEM : TUN-403

- 4 point seat belt with 48mm belts (ELR system)
- Easy to use automotive push button style latch system.
- 2" shoulder belts (wrap/snap hook fitting) with steel adjusters
- 2" lap belts with steel adjusters.
- Delivered with 7/16 UNF eye bolts.

STANDARD MEASURES

A 1800mm **B** 425mm **C** 560mm
GROSS WEIGHT 4.8KG

STANDARD COLORS

44001 TUN403 BLACK



TUN-301



ITEM : TUN-301

- 3 point static harness with 2" belts.
- Quick release buckle and ultra-thin webbing.
- 2" shoulder belts (wrap/snap hook fitting) with steel adjusters.
- 2"lap belts with steel adjusters.
- Delivered with bolt in.

STANDARD MEASURES

A	950mm	B	550mm	C	430mm
D	550mm	GROSS WEIGHT		1.34KG	

STANDARD COLORS

- | | | | | | |
|--------------------------------|-------------------------------|------------------------|-----------------------|--------------------|---------------------------------|
| 31001 TUN301 BLACK | 31002 TUN301 RED | 31003 TUN301 BLUE | 31004 TUN301 YELLOW | 31005 TUN301 GREEN | 31006 TUN301 PURPLE |
| 31007 TUN301 PINK | 31008 TUN301 ORANGE | 31009 TUN301 AQUA BLUE | 31010 TUN301 GREY | 31011 TUN301 CAMO | 31012 TUN301 FLUORESCENT YELLOW |
| 31013 TUN301 FLUORESCENT GREEN | 31014 TUN301 FLUORESCENT PINK | 31015 TUN301 TREE | 31016 TUN301 CHAMPION | | |

TUN-401



ITEM : TUN-401

- 4 point static harness with 2" belts
- According to ECE standard
- Quick release buckle and ultra-thin webbing
- 2" shoulder belts (wrap/snap hook fitting) with steel adjusters
- 2" lap belts with steel adjusters.
- Delivered with 7/16 UNF eye bolts.

STANDARD MEASURES

A	1350mm	B	425mm	C	560mm
GROSS WEIGHT		1.54KG			

STANDARD COLORS

- | | | | | | |
|--------------------------------|-------------------------------|------------------------|-----------------------|--------------------|---------------------------------|
| 43001 TUN401 BLACK | 43002 TUN401 RED | 43003 TUN401 BLUE | 43004 TUN401 YELLOW | 43005 TUN401 GREEN | 43006 TUN401 PURPLE |
| 43007 TUN401 PINK | 43008 TUN401 ORANGE | 43009 TUN401 AQUA BLUE | 43010 TUN401 GREY | 43011 TUN401 CAMO | 43012 TUN401 FLUORESCENT YELLOW |
| 43013 TUN401 FLUORESCENT GREEN | 43014 TUN401 FLUORESCENT PINK | 43015 TUN401 TREE | 43016 TUN401 CHAMPION | | |

2 POINT SEAT BELT



ITEM : SB-201

- 2 point seat belt with 48mm width polyester belts
- Fixed:18" Adjustable:42"

STANDARD COLORS

20001 SB201 BLACK **20002** SB201 RED
20003 SB201 YELLOW



ITEM : SB-202

- 2 point seat belt with 48mm width polyester belts
- Fixed:18" Adjustable:42"

STANDARD COLORS

21001 SB202 BLACK **21002** SB202 RED
21003 SB202 YELLOW



ITEM : SB-203

- 2 point seat belt with 48mm width polyester belts
- Fixed:18" Adjustable:42"

STANDARD COLORS

22001 SB203 BLACK **22002** SB203 RED
22003 SB203 YELLOW



ITEM : SB-204

- 2 point seat belt with 48mm width polyester belts
- Fixed:18" Adjustable:42"

STANDARD COLORS

23001 SB204 BLACK **23002** SB204 RED
23003 SB204 YELLOW



ITEM : SB-205

- 2 point seat belt with 48mm width polyester belts
- Fixed:18" Adjustable:42"

STANDARD COLORS

24001 SB205 BLACK **24002** SB205 RED
24003 SB205 YELLOW

**ITEM : SB-6001**

- 2 point seat belt with 48mm width polyester belts
- Fixed:18" Adjustable:42"

STANDARD COLORS

25001 SB6001 BLACK

**ITEM : SB-7003**

- 2 point seat belt with 48mm width polyester belts
- Fixed:18" Adjustable:42"

STANDARD COLORS

26001 SB7003 BLACK

3 POINT SEAT BELT**ITEM : SB-301**

- 3 point seat belt with 48mm width polyester belts
- Fixed:12" Adjustable:125"

STANDARD COLORS

30001 SB301 BLACK

**ITEM : SB-1010**

- 3 point seat belt with 48mm width polyester belts
- Fixed:12" Adjustable:125"

STANDARD COLORS

32001 SB1010 BLACK

**ITEM : SB-1015**

- 3 point seat belt with 48mm width polyester belts
- Fixed:12" Adjustable:125"

STANDARD COLORS

33001 SB1015 BLACK

HARDWARE



HARDWARE



HARDWARE

A-01



- 2 inch snap hook
- 80 g

A-01PVC



- 2 inch snap hook
- 80 g

A-01-SILVER



- 2 inch snap hook
- 80 g

A-02C



- 1 inch snap hook
- 36g

A-06

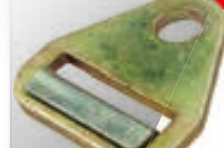

- 45mm End fitting
- 95 g

A-07



- 50mm slide bar
- 108 g

A-05



- 25mm End fitting
- 30 g

A-05B



- 25mm End fitting
- 30 g

T-08



- 45mm forged aluminum quick release
- 113g

T-09



- 45mm aluminum quick release
- 72g

T-10



- 45mm steel quick release
- 66g

T-18



- 45mm aluminum quick release
- 90g

T12



- Carabiner stainless steel
- 37 g

T13



- End fitting
- 100 g

SC-01-YELLOW



- 7/16 UNF eye bolt
- 56g

SC-03



- 7/16 UNF long eye bolt
- 162 g

A-13



- 1 inch snap hook
- 46g

A-14



- 3 inch snap hook
- 109g

LATCH AND LINK SYSTEM

A-08



- Soldering plate with a 7/16 thread nut
- 72x72mm
- 115g

LB2



- 2" latch and link
- 501 g

PAT. 7234011
PAT. D218692

LB2-FORGED



- 2" forged latch and link
- 508 g

PAT. 7234011
PAT. D218692

LB3



- 3" latch and link
- 797 g

PAT. 7234011
PAT. D218692

T03-L



- Left tongue
- 60g

T03-R



- Right tongue
- 60g

T04L



- Long crotch tongue
- 66g

T04S



- Short crotch tongue
- 58g

T05



- 2 inch link
- 97g

T05A



- 2 inch latch
- 229g

PAT. 7234011
PAT. D218692

T06



- 2 inch link (Forged)

T07



- 3 inch link
- 165g

T07A



- 3 inch latch
- 418g

PAT. 7234011
PAT. D218692

A-02A



- 2 inch bolt-in
- 63g

A-03



- 2 inch long bolt-in
- 73g

A-04



- 3 inch bolt-in
- 111g

A-15



- 3 inch bolt-in
- 86g

T22



- 3 inch long crotch tongue
- 82g

RATCHET MECHANISM INTRODUCTION

- 1** For either the left or right side use.
- 2** Ratcheting mechanism for our 16.1 SFI **three-inch or two-inch lap belts**.
- 3** Getting the belts tight enough in the heat of battle when off-road racing is very difficult.
- 4** C-shaped buckle, as a limit function, to prevent the separation of the central shaft.
- 5** A faster and tighter adjustment of the lap belt without any assistance.
- 6** Capable of withstanding harsh racing conditions and environments such as back-to-back dirt track events or extreme Baja racing.
- 7** Electric black surface treatment, salt spray resistance test
- 8** Double locking design for added safety.
- 9** All kinds of 1/4 inch wrench available.

PAT. D224731



RATCHET MECHANISM

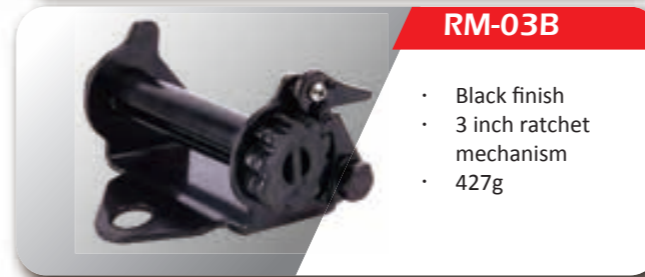

TUNING PARTS / SEAT BELT BUCKLE

TUN-01  • 2" • 162g	TUN-02  • 1" • 124g	TUN-03  • 1" • 124g	TUN-04  • 2" • 175g
AD-04  • 58g	SC-02  • 43g	TUN-05  • 2" • 140g	TUN-06  • 2" • 135g
TUN-07  • 1" • 104g	TUN-08  • 2" • 116g	TUN-09  • 2" • Quick release buckle • 169g	TUN-10  • 45mm • Bus seat belt buckle • 221g
TUN-11  • 45mm • Bus seat belt buckle • 171g			

WINDOW NETS



- Most universal size: 18" x 24".
- SFI 27.1 rating, with SFI tag.
- Valid contribution for safety, 1" polypropylene webbing.
- With the best sewing structure.
- Manufacturing for consistency.

ITEM : WAB-01

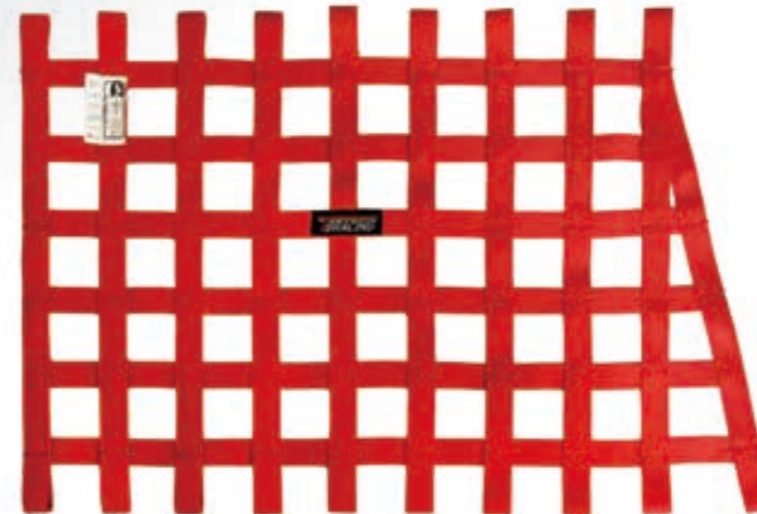

ITEM : WSY-01

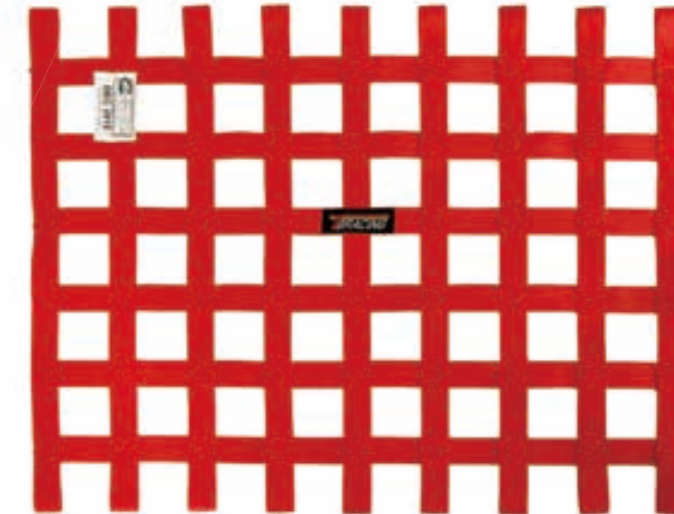

STANDARD COLORS

- | | | |
|---------------------------|--------------------------|---------------------------|
| 71001 WAB01 BLACK | 71002 WAB01 RED | 71003 WAB01 BLUE |
| 71004 WAB01 YELLOW | 71005 WAB01 GREEN | 71006 WAB01 PURPLE |
| 71007 WAB01 ORANGE | 71008 WAB01 GREY | |

STANDARD COLORS

- | | | |
|---------------------------|--------------------------|---------------------------|
| 72001 WSY01 BLACK | 72002 WSY01 RED | 72003 WSY01 BLUE |
| 72004 WSY01 YELLOW | 72005 WSY01 GREEN | 72006 WSY01 PURPLE |
| 72007 WSY01 ORANGE | 72008 WSY01 GREY | |

WINDOW NETS

WSY-2100

- In compliance with sfi regulation
- **Latch style flat bar with flat bar**
- Most universal size: 18" x 24"
- Valid contribution for safety, 1" polypropylene webbing
- With the best sewing structure
- Manufacturing for consistency



WSY-2200

- In compliance with sfi regulation
- **Quick release with push button with round bar**
- Most universal size: 18" x 24"
- Valid contribution for safety, 1" polypropylene webbing
- With the best sewing structure
- Manufacturing for consistency

STANDARD COLORS

- | | | |
|-----------------------------|----------------------------|-----------------------------|
| 75001 WSY2200 BLACK | 75002 WSY2200 RED | 75003 WSY2200 BLUE |
| 75004 WSY2200 YELLOW | 75005 WSY2200 GREEN | 75006 WSY2200 PURPLE |
| 75007 WSY2200 ORANGE | 75008 WSY2200 GREY | |

STANDARD COLORS

- | | | |
|-----------------------------|----------------------------|-----------------------------|
| 73001 WSY2100 BLACK | 73002 WSY2100 RED | 73003 WSY2100 BLUE |
| 73004 WSY2100 YELLOW | 73005 WSY2100 GREEN | 73006 WSY2100 PURPLE |
| 73007 WSY2100 ORANGE | 73008 WSY2100 GREY | |

WSY-2100R

- In compliance with sfi regulation
- **Latch style round bar with round bar**
- Most universal size: 18" x 24"
- Valid contribution for safety, 1" polypropylene webbing
- With the best sewing structure
- Manufacturing for consistency

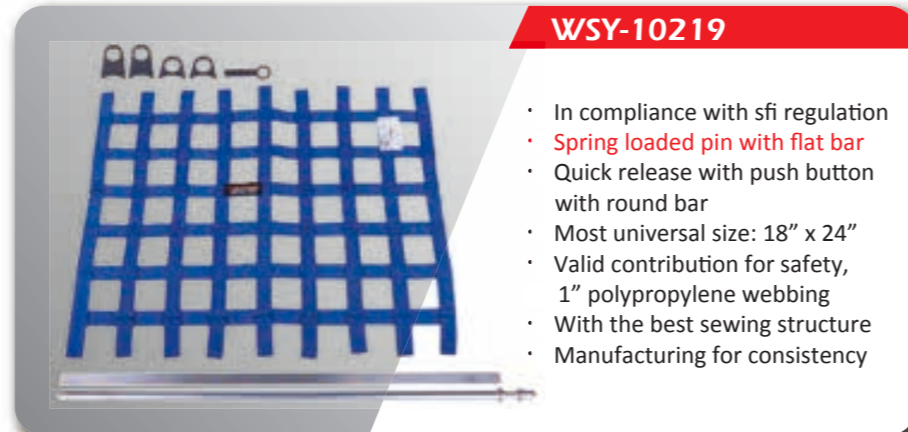

WSY-10219

- In compliance with sfi regulation
- **Spring loaded pin with flat bar**
- Quick release with push button with round bar
- Most universal size: 18" x 24"
- Valid contribution for safety, 1" polypropylene webbing
- With the best sewing structure
- Manufacturing for consistency

STANDARD COLORS

- | | | |
|------------------------------|-----------------------------|------------------------------|
| 76001 WSY10219 BLACK | 76002 WSY10219 RED | 76003 WSY10219 BLUE |
| 76004 WSY10219 YELLOW | 76005 WSY10219 GREEN | 76006 WSY10219 PURPLE |
| 76007 WSY10219 ORANGE | 76008 WSY10219 GREY | |

STANDARD COLORS

- | | | |
|------------------------------|-----------------------------|------------------------------|
| 74001 WSY2100R BLACK | 74002 WSY2100R RED | 74003 WSY2100R BLUE |
| 74004 WSY2100R YELLOW | 74005 WSY2100R GREEN | 74006 WSY2100R PURPLE |
| 74007 WSY2100R ORANGE | 74008 WSY2100R GREY | |

WINDOW NETS

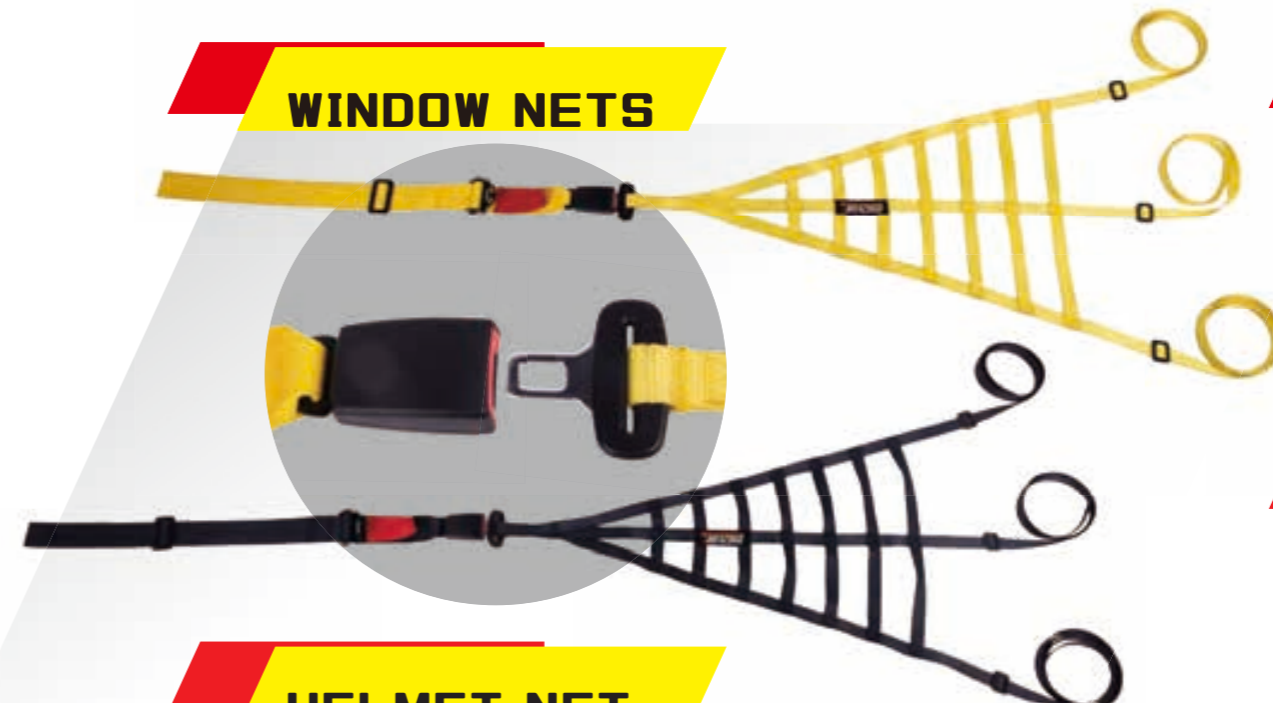

ITEM : RN-01

- In compliance with FIA regulation
- Triangular assembly
- With 2 inch superfast adjuster and quick release buckle
- Valid contribution for safety, 1 inch polypropylene webbing

STANDARD COLORS

- | | |
|-------------------------------------|--------------------------|
| 78001 RN01 BLACK | 78002 RN01 YELLOW |
| 78003 RN01 BLUE | |
| 78004 RN01 FLUORESCENT GREEN | |

HELMET NET



HN-01

- Polyester helmet carrying net
- Suitable for all cars, can hold 2 helmets
- Attaches To Roll Cage via adjustment buckles and straps.



HN-02

- Polyester helmet carrying net
- Suitable for all cars, can hold 2 helmets
- Attaches To Roll Cage via adjustment buckles and straps.

TOW STRAPS



ITEM : TS-01

- The strongest break strength: 2 tons.
- Using length: 30cm
- Bolt-hole centre ID is 12.5mm.
- Durable polyester 2" webbing.
- Customized length with all kinds of colors.

STANDARD COLORS

77001	TS01 BLACK	77002	TS01 RED	77003	TS01 BLUE
77004	TS01 YELLOW	77005	TS01 GREEN	77006	TS01 PURPLE
77007	TS01 PINK	77008	TS01 ORANGE	77009	TS01 AQUA BLUE
77010	TS01 GREY	77011	TS01 CAMO	77012	TS01 FLUORESCENT YELLOW
77013	TS01 FLUORESCENT GREEN	77014	TS01 FLUORESCENT PINK		
77015	TS01 TREE	77016	TS01 CHAMPION		

ARM RESTRAINT



- In compliance with SFI regulation
- Set comes in a pair
- For use Dragster, Midget and Off Road racing.

AR-01 (ADULT) STANDARD COLOR

79001	AR01 BLACK	79002	AR01 RED	79003	AR01 BLUE
-------	------------	-------	----------	-------	-----------

AR-02 (JUNIOR) STANDARD COLOR

80001	AR02 BLACK	80002	AR02 RED	80003	AR02 BLUE
-------	------------	-------	----------	-------	-----------

CAM BUCKLE

3/4"

CB-15

- zinc alloy
- B/S:120kgs (260lbs)
- 18g

1"

S03-P

- Plastic
- B/S:100kgs (220lbs)
- 15g

S05

- Zinc alloy
- B/S:250kgs (550lbs)
- 39g

S03

- Zinc alloy
- B/S:350kgs (770lbs)
- 61g

35mm

S07

- Zinc alloy
- B/S:700kgs (1540lbs)
- 124g

CB-03

- Zinc alloy
- B/S:550kgs (1200lbs)
- 48g

CB-04

- Frame: steel
- cam: zinc alloy
- B/S:550kgs (1200lbs)
- 89g

CB-04L

- Frame: steel
- cam: zinc+rubber
- B/S:550kgs (1200lbs)
- 91g

S04

- Frame: steel
- cam: zinc alloy
- B/S:650kgs (1340lbs)
- 119g

S11

- Frame: steel
- cam+gasket: zinc alloy
- B/S:750kgs (1650lbs)
- 172g

S04-1

- Steel
- B/S:1000kgs (2200lbs)
- 141g

S13

- Frame: steel
- cam: zinc+rubber
- B/S:500kgs (1100lbs)
- 122g

S03-S

- Stainless steel
- B/S:450kgs (990lbs)
- 66g

S04-S

- Stainless steel
- B/S:500kgs (1100lbs)
- 123g

S05C

- Zinc alloy
- B/S:250kgs (550lbs)
- 45g

1.5"

CB-13



- Frame: steel
- cam: zinc alloy
- B/S: 750kgs (1650lbs)
- 135g

CB-14



- Zinc alloy
- B/S: 700kgs (1540lbs)
- 120g

S24-S



- Stainless steel
- B/S: 700kgs (1540lbs)
- 89g

2"

S12



- Frame: steel
- cam+gasket: zinc alloy
- B/S: 1500kgs (3300lbs)
- 248g

RATCHET BUCKLE

S09



- 1 inch
- Mini
- B/S: 800 kgs

S09-S



- 1 inch
- Stainless Steel
- B/S: 400 kgs

S10



- 1 inch
- Heavy-duty
- B/S: 1500 kgs

S25



- 1 inch
- red soft handle
- B/S: 1200 kgs

S26



- 1 inch
- Light-duty
- B/S: 1800 kgs

S27



- 1.5 inch
- black soft handle
- B/S: 1800 kgs

S21



- 2 inch
- Long Lever
- B/S: 5000 kgs

S22



- 2 inch
- Long Lever
- B/S: 5000 kgs

S28



- 2 inch
- black soft handle
- B/S: 5000 kgs

S29



- 2 inch
- Medium Lever
- B/S: 5000 kgs

S30



- 2 inch
- Long Lever
- B/S: 5000 kgs

S31



- 19mm
- B/S: 300kgs

OVERCENTER BUCKLE

B01



- 1 inch
- B/S: 500 kgs (1100 lbs)

B03



- 1 inch
- Stainless steel
- B/S: 450 kgs (990 lbs)

B05



- 1 inch
- B/S: 700 kgs (1540 lbs)

B02



- 2 inch
- B/S: 700 kgs (1540 lbs)

B04

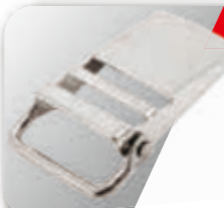

- 2 inch
- Stainless steel
- B/S: 650 kgs (1430 lbs)

B06



- 2 inch
- B/S: 500 kgs (1100 lbs)

RATCHET STRAPS

SA09



- 1 inch ratchet strap
- B/S: 800 kgs (1760 lbs)

RR01



- 1 inch retractable ratchet strap
- B/S: 600 kgs (1300 lbs)

SA15



- 2 inch ratchet strap
- B/S: 2000 kgs (4400 lbs)

RR02



- 2 inch retractable ratchet strap
- B/S: 1500 kgs (3300 lbs)

SA16



- 2 inch ratchet strap
- B/S: 5000 kgs (11000 lbs)

SPARE TIRE STRAP

STS09

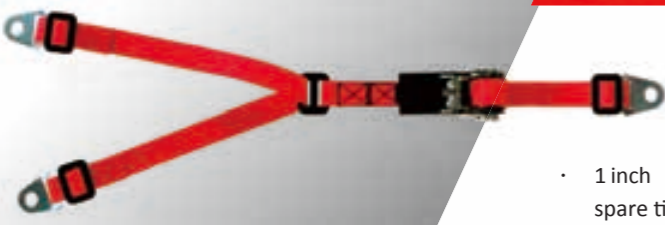

- 1 inch spare tire strap

STS25



- 1 inch spare tire strap

STS09-P



- 1 inch spare tire strap

STS27



- 38 mm spare tire strap

STS16-4M



- 2 inch spare tire strap

STS22



- 2 inch spare tire strap



TU5



- 38mm 3-bar
- 35g

A-09



- 1.5 inch twist hook
- 160g

T-19



- 50mm D ring
- 86g

A-10



- 2 inch twist hook
- 320g

T-20

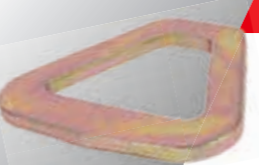

- 50mm delta ring
- 95g

A-11



- 2 inch hook
- 314g

T-21



- 50mm O ring
- 86g

A-12



- S hook with spring
- 105g



TIE DOWN STRAPS



S03-W

- 1 inch
- B/S:350kgs (770 lbs)



S03P-W

- 1 inch
- B/S:100kgs (220 lbs)



CB03-W

- 1 inch
- B/S:550kgs (1200lbs)



S05-W

- 1 inch
- B/S:100kgs (220lbs)



S09-W

- 1 inch ratchet
- B/S:900kgs (1900 lbs)



SH03

- 1 inch
- B/S: 350kgs (770 lbs)



SH04

- 1 inch
- B/S: 650kgs (1340 lbs)



SH11

- 1 inch
- B/S: 750kgs (1650 lbs)



CB04LH

- 1 inch
- B/S: 550kgs (1200 lbs)



CB13LH

- 1.5 inch
- B/S: 750KGS (1650 lbs)



SHB03

- 1 inch stainless steel overcenter buckle



SH01

- 1 inch overcenter buckle



SHB05

- 1 inch overcenter buckle



SHB02

- 2 inch overcenter buckle



SHB04

- 2 inch stainless steel overcenter buckle

PADDING

PD-01 / PD-02

- Customized logo
- Measures 2 inches and 3 inches in size
- Set comes in a pair



2" STANDARD COLORS

82001 PD01 BLACK 82002 PD01 RED 82003 PD01 BLUE

3" STANDARD COLORS

83001 PD02 BLACK 83002 PD02 RED 83003 PD02 BLUE

HAND TOOLS

HT-01



- 10 pieces allen keys

HT-02



- 14 pieces combination wrench set
- Size : 8~24mm

HT-03



- 18 pieces 1/4 inch socket set

HT-04



- 42 pieces power bits set hardware tools

HT-05



- 1/2 inch impact socket bit set
- Torx Bit Type: T30,T40, T45,T47,T50,T55,T60,T70
- Hex Bit Type: H6,H7,H8, H10,H12,H14,H17,H19

HT-06



- 12 inch double head wrench tool
- Size: 6mm-19mm

HT-07



- 1/4 inch low profile ratchet sockets tool kits

ACCESSORIES

HT-08



- 3pcs 1/2 inch alloy wheel nut socket
- Size: 17, 19 ,21mm

HT-09



- 17 piece 1/2 inch drive 6 pt socket set

HT-10



- 72 teeth extendable ratchet tool

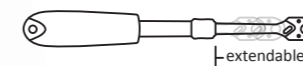

HT-11



- 250mm water pump plier

HT-12



- 250mm water pump plier
- The maximum opening is 50mm

HT-13



- 150mm cable cutter
- Drop forged and heat treated

HT-14



- 190mm pliers
- colors: Silver

STEERING WHEEL



ITEM : SW-01

- Made from high quality leather
- Improves the grip and control of your vehicle
- Provides a more sporty feel to your vehicle
- 5mm thickness

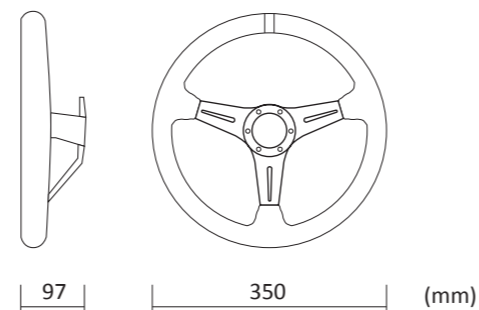

STEERING WHEEL



ITEM : SW-03

- Made from high quality leather
- Improves the grip and control of your vehicle
- Provides a more sporty feel to your vehicle
- 4mm thickness
- aluminum horn cover

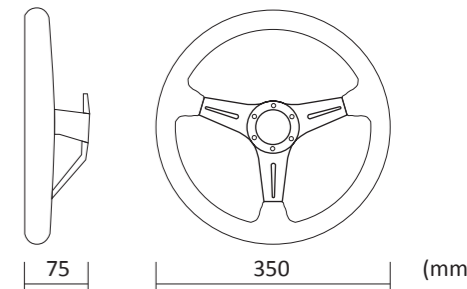

ITEM : SW-02

- Made from high quality leather
- Improves the grip and control of your vehicle
- Provides a more sporty feel to your vehicle
- 4mm thickness
- aluminum horn cover

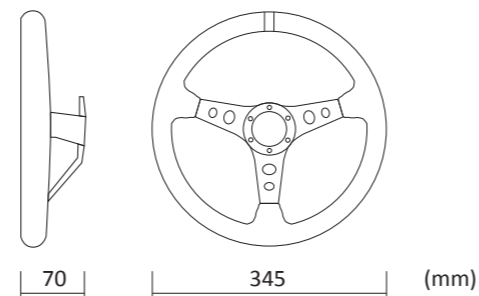

ITEM : SW-04

- Made from high quality leather
- Improves the grip and control of your vehicle
- Provides a more sporty feel to your vehicle
- 4mm thickness
- aluminum horn cover

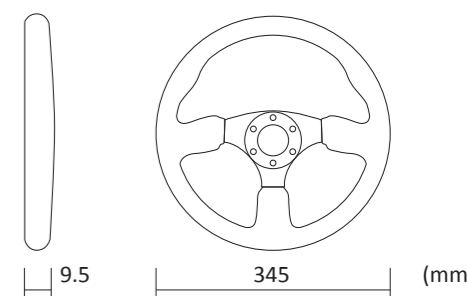

BONNET PINS

BP-02

- Material: aluminum
- Color: red,blue,silver,black
- Size: Ø12



STANDARD COLORS

- 94001 BP02 BLACK
- 94002 BP02 RED
- 94003 BP02 BLUE
- 94004 BP02 SILVER
- 94005 BP02 PURPLE

BP-03

- Aero catch plus flush kit
- Panel fasteners are designed for bonnet /hood, boot /trunk, tailgates



BP-04

- Competition boot springs
- Material: stainless steel



HOOD PINS LOCK CLIP

HP-01

- Head size latch : 1.0"(25mm) 1.25"(32mm) / 2.5"(64mm)
- Length of mounting stud : 2.13"(54mm)/4"(100mm)



STANDARD COLORS

- 92001 HP01 BLACK
- 92002 HP01 RED
- 92003 HP01 BLUE
- 92004 HP01 SILVER

STEERING WHEEL QUICK RELEASE

QR-01

- Material : aluminum
- Size : 3.3 inch(D) x 2.56 inch (H)
- Ball-Lock type mechanism for best locking fit and usability
- Fast detach allows steering wheel to be removed quickly
- Push-pin security feature prevents premature unlocking
- Compatible with 6-hole steering wheel hub kit



STANDARD COLORS

- 91001 QR01 BLACK
- 91002 QR01 RED
- 91003 QR01 BLUE
- 91004 QR01 GOLD

QR-02

- Material: aluminum \ steel
- Size: 25 x 10mm
- Ball-Lock type mechanism for best locking fit and usability
- Fast detach allows steering wheel to be removed quickly



STANDARD COLORS

- 93001 QR02 RED
- 93002 QR02 BLUE
- 93003 QR02 SILVER

SAFETY HAMMER

HA-10005

- Size: 137(L) x 88(W) x 32(H)mm
- Weight: 158 g



HA-10006

- Size: 188(L) x 80(W) x 35(H)mm
- Weight: 200g



SEAT BELT CUTTER

CU-5258

- Material: Plastic
- Size: 123(L) x 44(W) x 6(H)mm
- Weight: 19g



COUPE-CIRCUIT

TP-01



- T pull cable
- Length of mounting: 1.5m / 3m

S-01

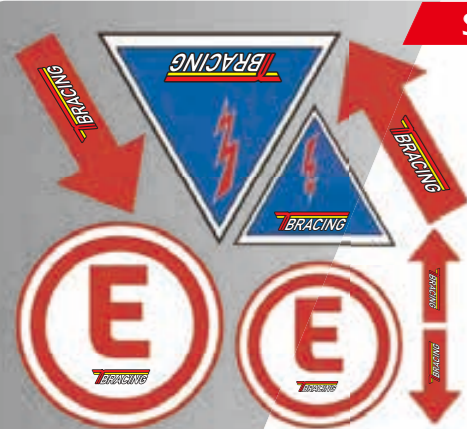

- Fire extinguisher sticker
- Circuit breaker sticker
- Arrow sticker

PS-01



- 6 poles switch cut out, (fia)
- Inside all conducting part use copper

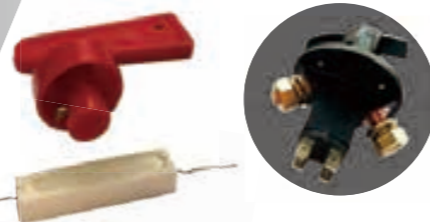

PS-02



- 4 poles switch cut out
- Inside all conducting part use copper



PS-03



- 2 poles switch cut out
- Inside all conducting part use copper



HYDRAULIC HANDBRAKE KIT

HHB-01



- Aluminum alloy hydraulic handbrake
- cylinder inner dia: 0.75" (1.9cm)

HHB-02



- Aluminum alloy hydraulic handbrake
- 50cm

HHB-03



- Aluminum oxide handle handbrake
- 63 cm

STANDARD COLORS

- 95001 HHB01 BLACK
- 95002 HHB01 RED
- 95003 HHB01 BLUE
- 95004 HHB01 GOLD

STANDARD COLORS

- 96001 HHB02 BLACK
- 96002 HHB02 RED
- 96003 HHB02 BLUE
- 96004 HHB02 GOLD

STANDARD COLORS

- 97001 HHB03 BLACK
- 97002 HHB03 RED
- 97003 HHB03 BLUE
- 97004 HHB03 GOLD

HHB-04



- Aluminum oil hydraulic handbrake
- 40cm



HHB-05



- Aluminum oil hydraulic handbrake
- cylinder inner dia: 0.7"



STANDARD COLORS

- 98001 HHB04 BLACK
- 98002 HHB04 RED
- 98003 HHB04 BLUE
- 98004 HHB04 GOLD
- 98005 HHB04 NEO CHROME

STANDARD COLORS

- 99001 HHB05 SILVER

FIRE EXTINGUISHER



ITEM : FE-01

- 4.25L Electrical Rally Car Fire Extinguisher.
- Stainless Steel Type.
- The kit complies with current FIA and MSA regulations.
- For use in all enclosed cockpit vehicles.
- Dimensions: Cylinder Length 330mm, cylinder diameter 160mm.
- Weight: Complete system 6.2kg.

Aluminum tube,
each 4m
2XNozzle
6X90° connections
2X3-ways connector
1XT connector
4XControl box
1XWiring harness
1XStickers
2XSwitches
2X

ITEM : FE-02

- 4.25L Mechanically Rally Car Fire Extinguisher.
- Carbon Steel Type.
- The kit complies with current FIA and MSA regulations.
- For use in saloon cars, rally cars, GT and sports cars.
- Dimensions: Cylinder Length 330mm, cylinder diameter 160mm.
- Weight: Complete system 8.5kg.

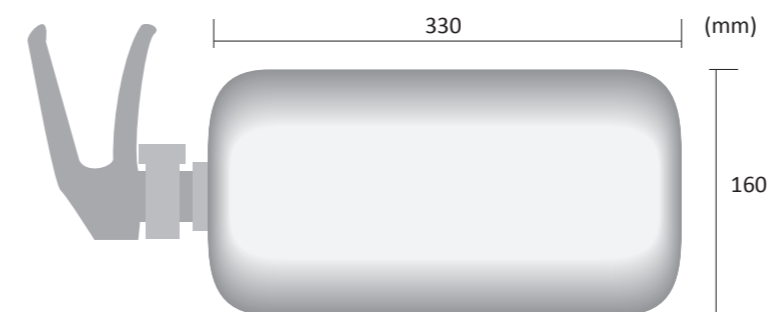
Aluminum tube,
each 4m
2XPulling cable
2XNozzle
6X90° connections
2X3-ways connector
1XT connector
4X

FIRE EXTINGUISHER



ITEM : FE-03

- Powder ABC 2Kg extinguisher
- Steel tank Type
- The kit complies with EN615
- For use in caravan car, vehicle , boats, home
- Dimensions: Cylinder Length 395mm, cylinder diameter 110mm
- Weight: Complete system 3.75kg

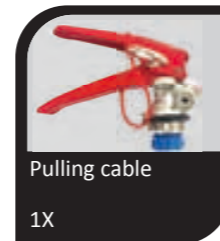
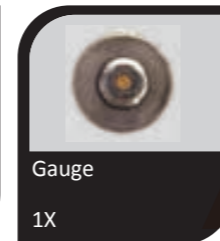
Bracket
1XPulling cable
1XGauge
1XNozzle
1XDiptube
1X

APPLICATION

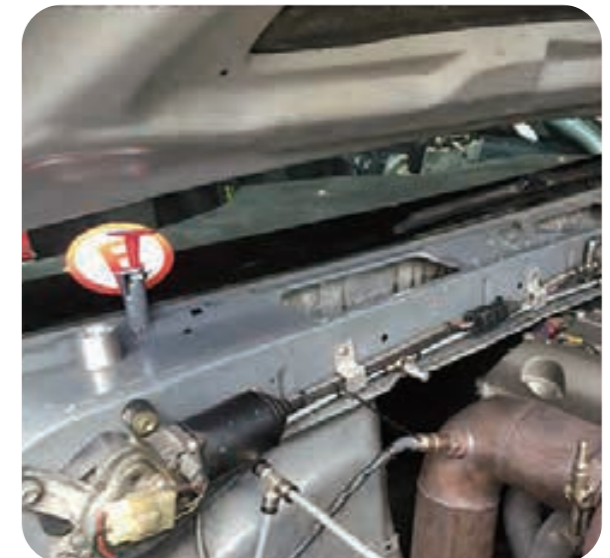
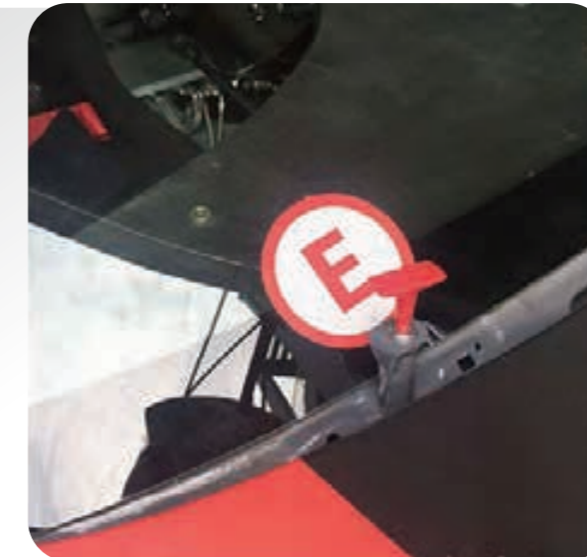

VEHICLE EQUIPMENT RACING SEAT

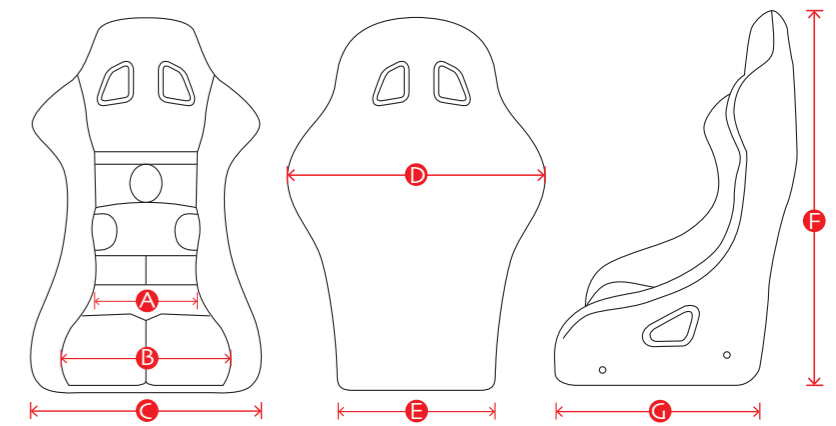

ITEM : RS-01

DIMENSIONS (MM)						
A	B	C	D	E	F	G
300	380	490	570	390	880	450
WEIGHT : 8 kg						

ITEM : RS-01W

DIMENSIONS (MM)						
A	B	C	D	E	F	G
390	450	560	610	460	880	450
WEIGHT : 10 kg						

Customized your own seat



RACING SEAT

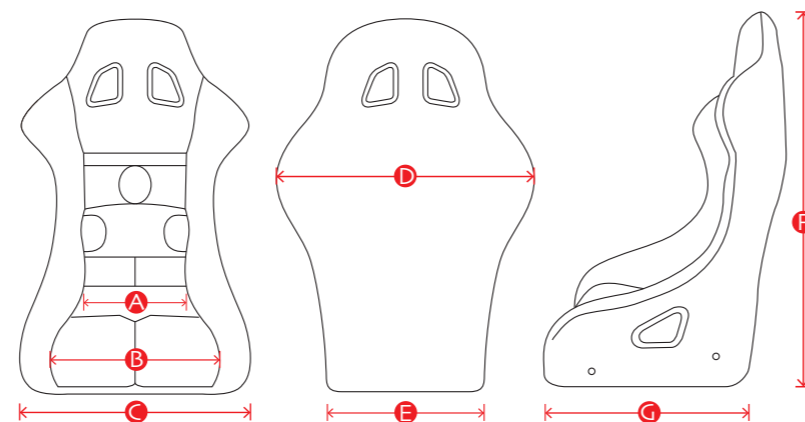

ITEM : RS-02

DIMENSIONS (MM)						
A	B	C	D	E	F	G
310	370	500	590	380	910	480
WEIGHT : 8.32 kg						

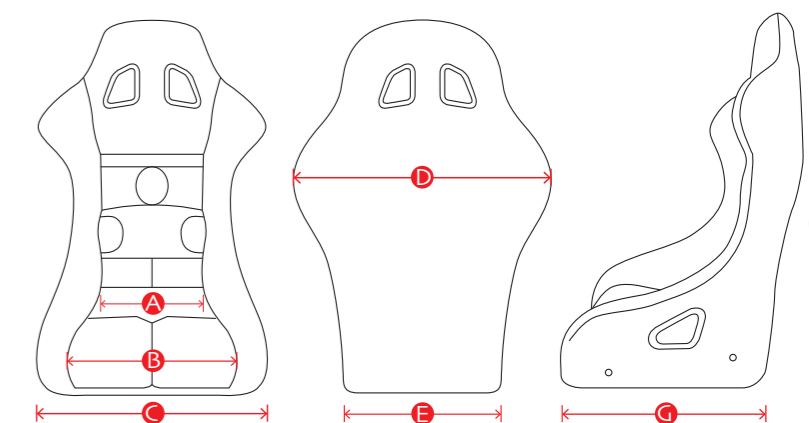

ITEM : RS-03

DIMENSIONS (MM)						
A	B	C	D	E	F	G
320	370	500	580	390	930	530
WEIGHT : 9.24 kg						



RACING SEAT

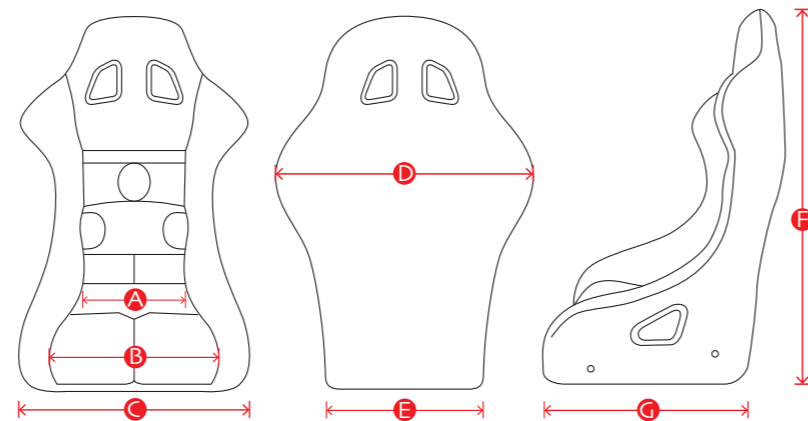

ITEM : RS-04

DIMENSIONS (MM)						
A	B	C	D	E	F	G
300	380	470	500	410	970	480
WEIGHT : 14.43 kg						

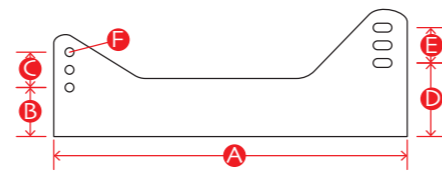

ITEM : RS-11

· Universal seat mount

DIMENSIONS (MM)					
A	B	C	D	E	F
360	50	36	75	36	9

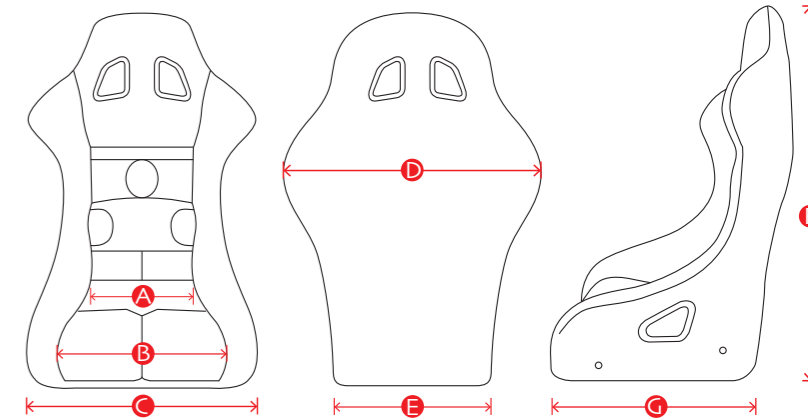

ITEM : RS-05

DIMENSIONS (MM)						
A	B	C	D	E	F	G
300	370	515	500	400	990	550
WEIGHT : 16.04 kg						



ITEM : RS-12

· Sliding tracks

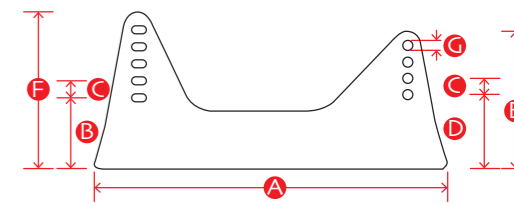

ITEM : RS-13

· Universal seat mount

DIMENSIONS (MM)						
A	B	C	D	E	F	G
360	70	18	75	145	157	10

HELMETS



ITEM : HE-01

- 3/4 HELMET
- FIA 8859-2015 STANDARD & SNELL SA2015
- Fiberglass and Kevlar fibers are used to produce our helmets , come with SCHROTH Hansanchors/ pins.
- 8 sizes avallable : 3XS,2XS,XS,S,M,L,XL,XXL
- Weight : 1600 grams.
- Color: white & black

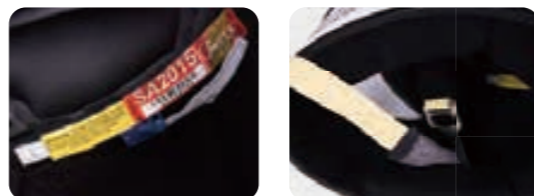

ITEM : HE-02

- Full HELMET
- FIA 8859-2015 STANDARD & SNELL SA2015
- Fiberglass and Kevlar fibers are used to produce our helmets , come with SCHROTH Hansanchors/pins.
- 8 sizes avallable : 3XS,2XS,XS,S,M,L,XL,XXL
- Weight : 1750 grams.
- Color: white & black

HELMETS SIZE (CM)

3XS	2XS	XS	S	M	L	XL	2XL
49-50	51-52	53-54	55-56	57-58	59-60	61-62	63-64



ITEM : HE-03

- 3/4 HELMET with chin boom
- FIA 8859-2015 STANDARD & SNELL SA2020
- Fiberglass and Kevlar fibers are used to produce our helmets , come with SCHROTH Hansanchors/pins.
- 8 sizes available : 3XS,2XS,XS, S, M, L, XL, XXL
- Weight : 1620 grams.
- Color: white & black



ITEM : HE-04

- 3/4 HELMET carbon with chin boom
- FIA 8859-2015 STANDARD & SNELL SA2020
- Fiberglass and Kevlar fibers are used to produce our helmets , come with SCHROTH Hansanchors/pins.
- 8 sizes available : 3XS,2XS,XS, S, M, L, XL, XXL
- Weight : 1450 grams

HELMETS SIZE (CM)

3XS	2XS	XS	S	M	L	XL	2XL
49-50	51-52	53-54	55-56	57-58	59-60	61-62	63-64

